

FREEBIE

Writing Practice Sheets

Numbers & Letters

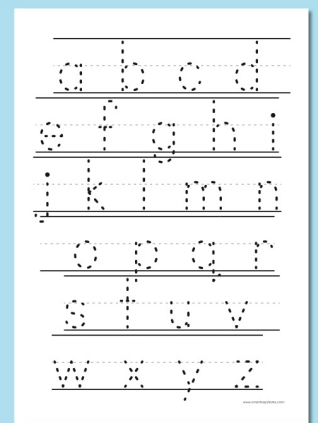
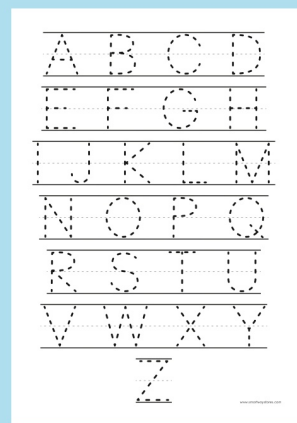
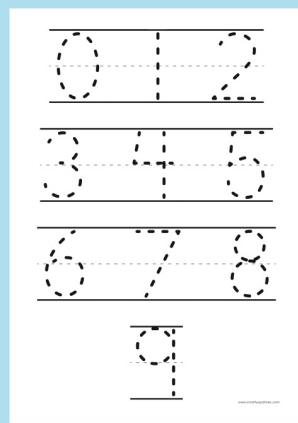
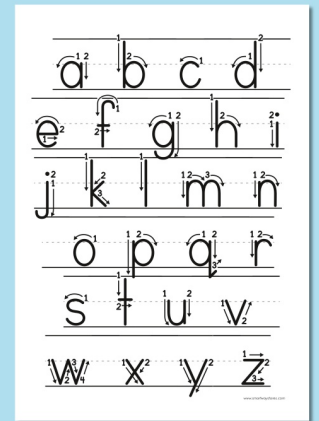
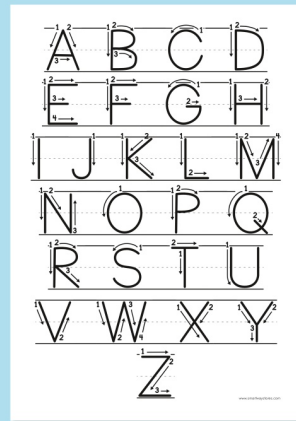
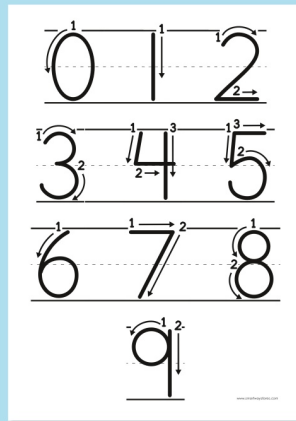
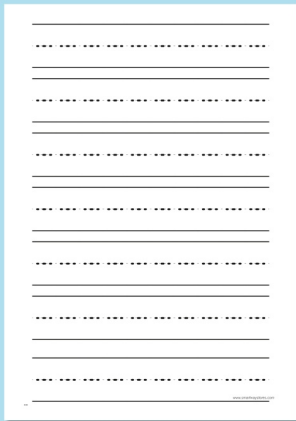

2 styles: dotted & instructions

Thankyou



I want to take a moment to thank you for the recent purchase. It is my pleasure to assist you. By downloading this resource, you are agreeing to the term listed below.

You may

- Use this resource at home with your child or students.
- Use this resource with multiple students in a classroom/tutoring setting.
- Share the source of this resource with your colleagues by directing them to the store to get their own copies

You may not

- You may not share it or put it on internet.
- You may not sell or distribute it in any format/manner.

Copyright©2024 Smart Way
- All rights reserved.
Permission to use for a single
classroom use only (for both
digital and printable)

Get Access to Our Exclusive Freebie Library

Subscribe and get access to our exclusive freebie library and stay updated... [click here](#)

Let's Connect



Credits

Fonts



Illustrations



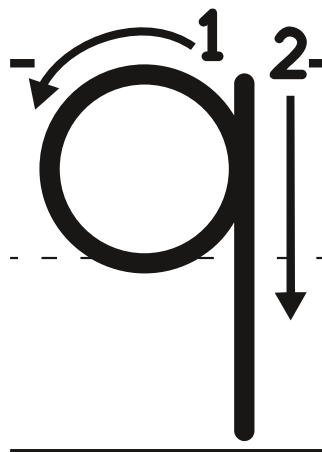
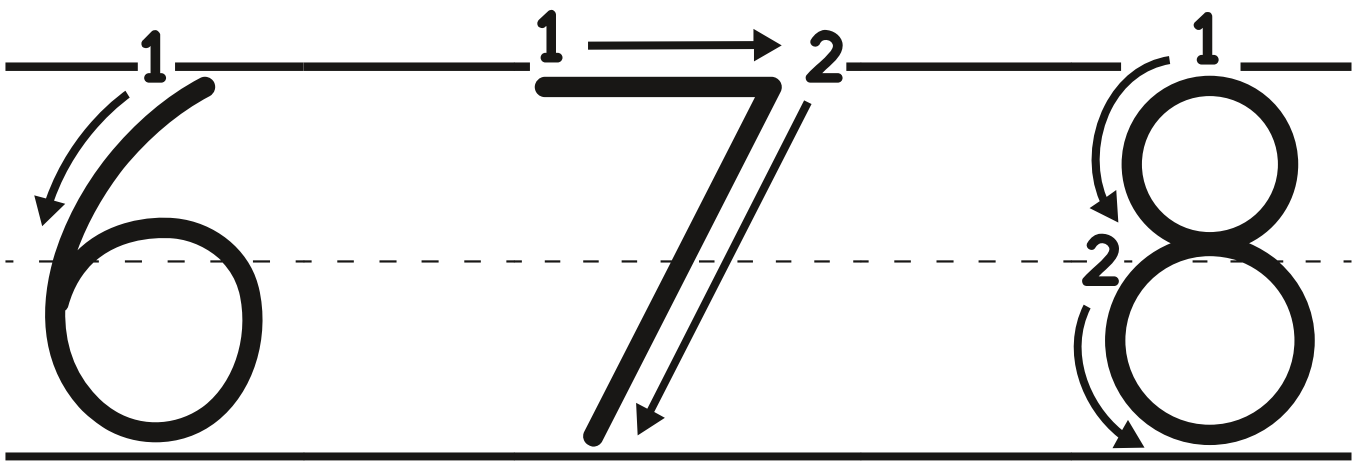
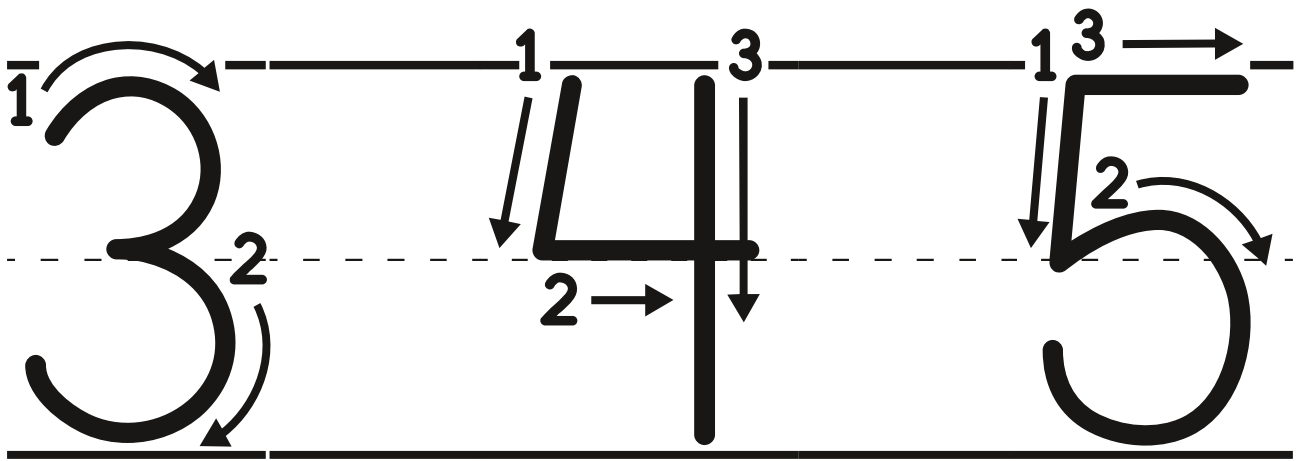
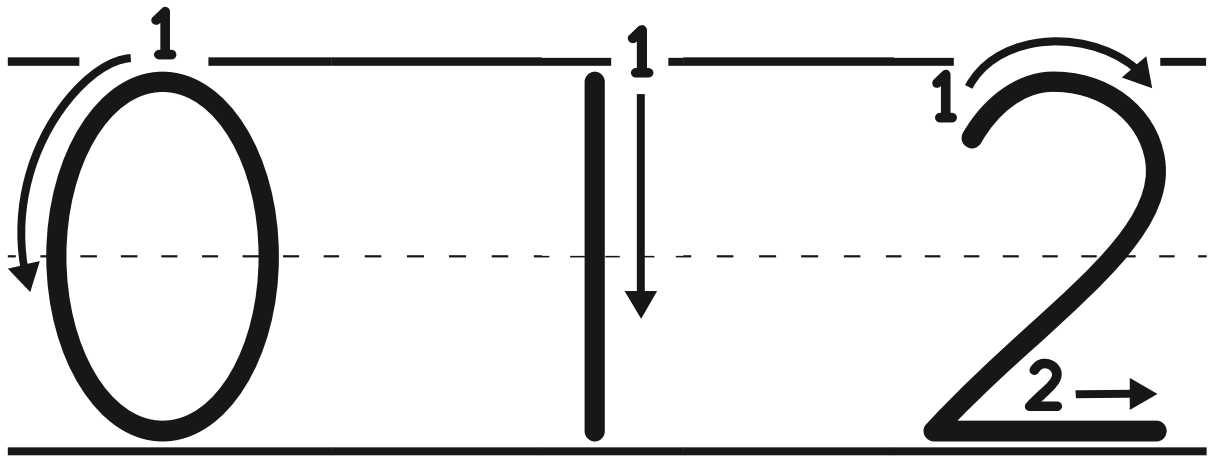

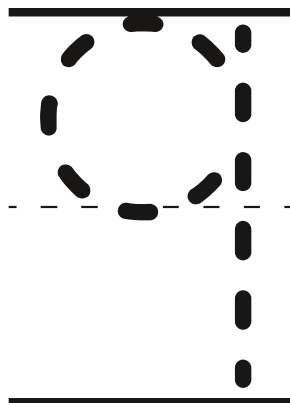
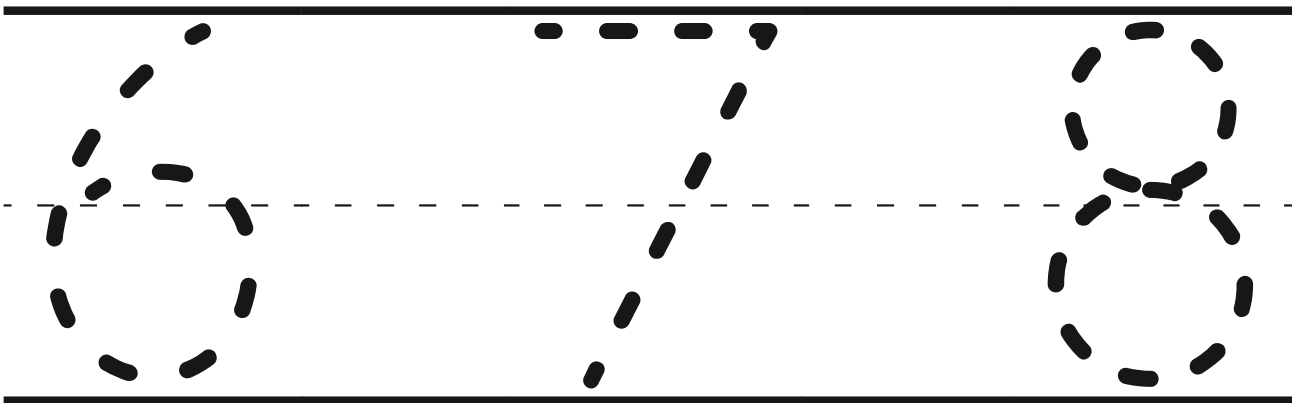
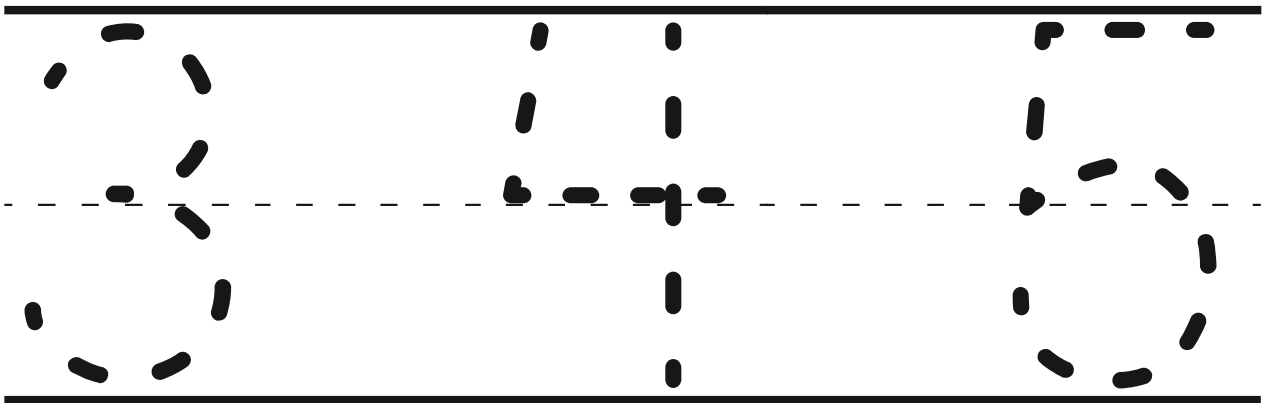
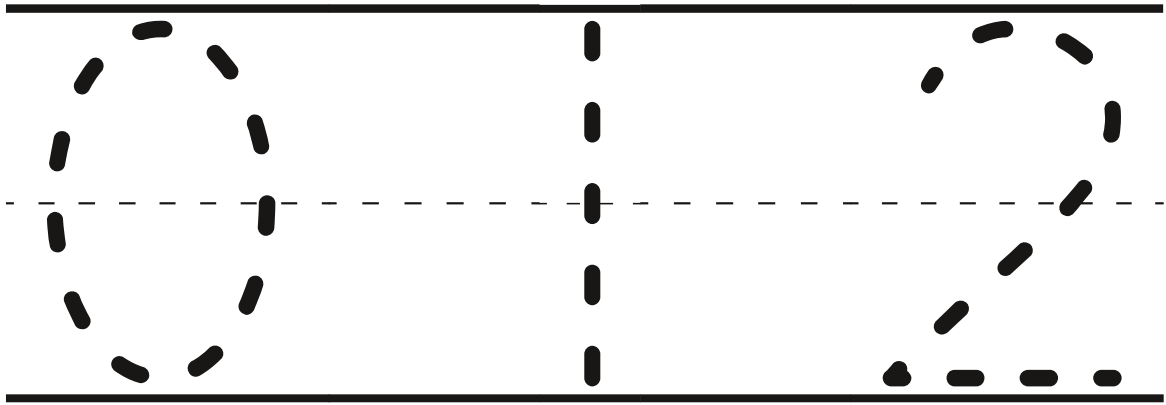

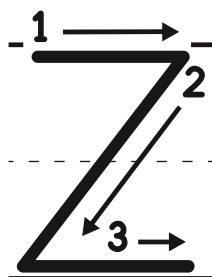
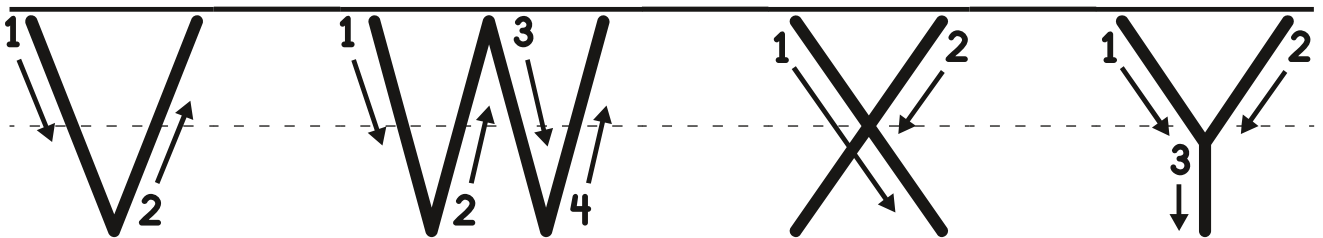
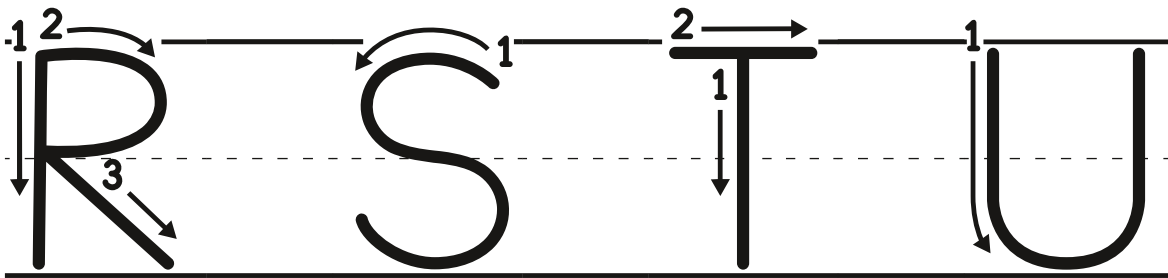
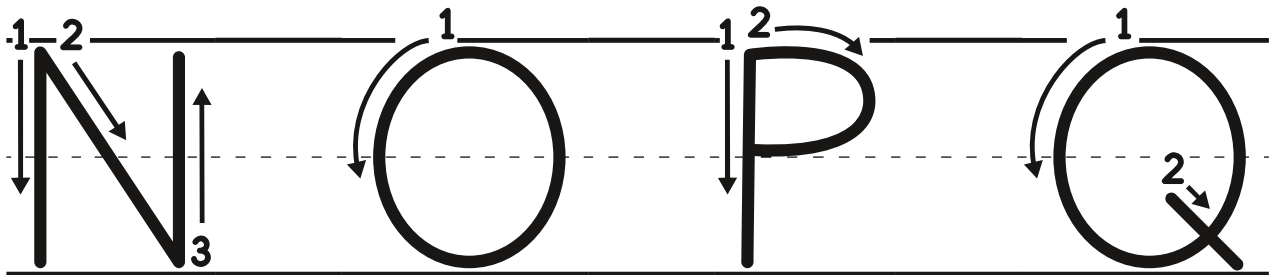
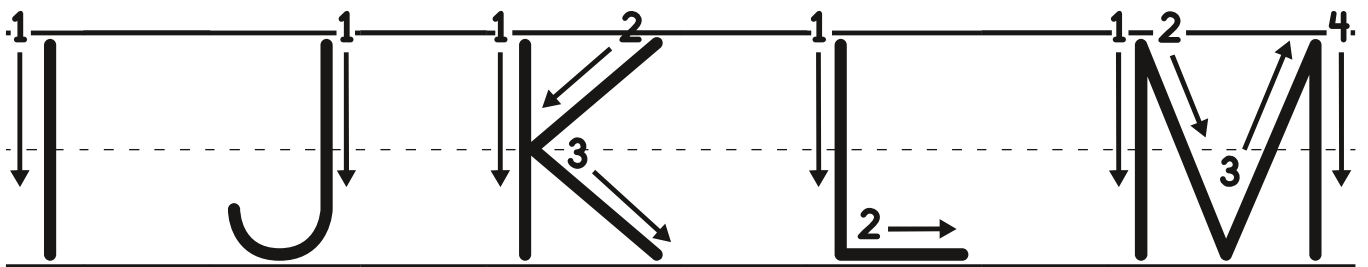
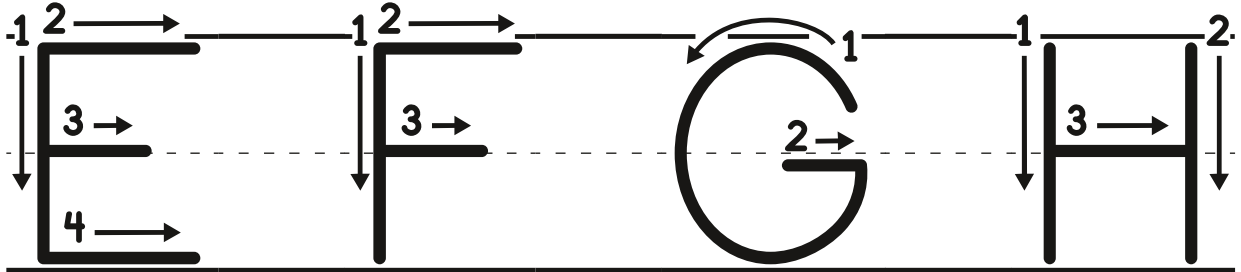
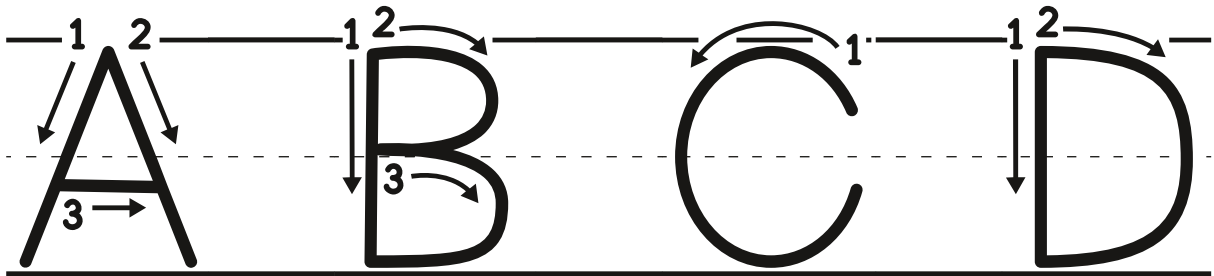

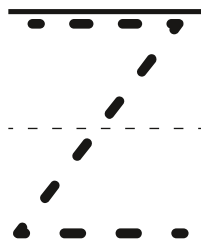
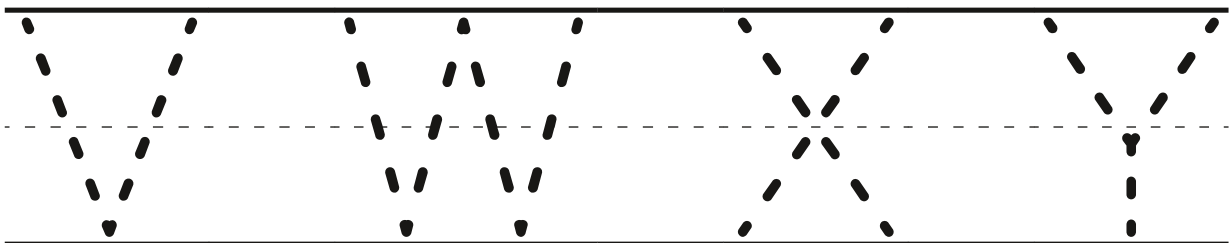
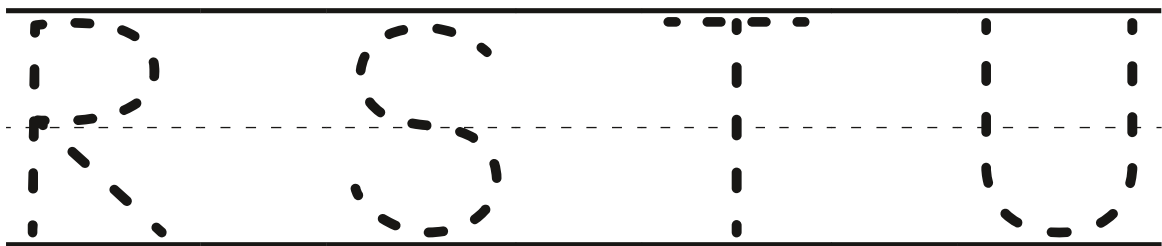
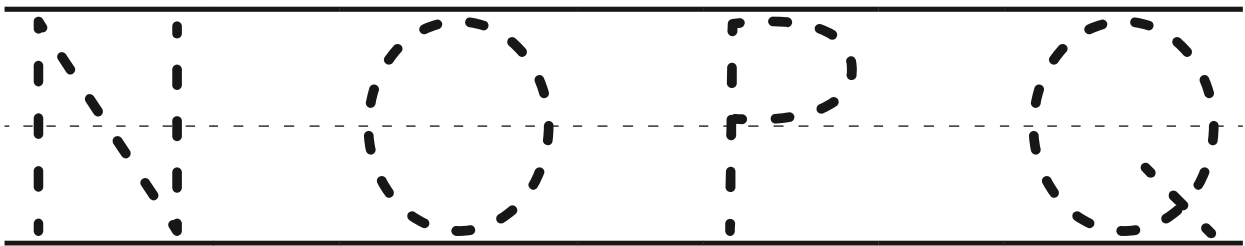
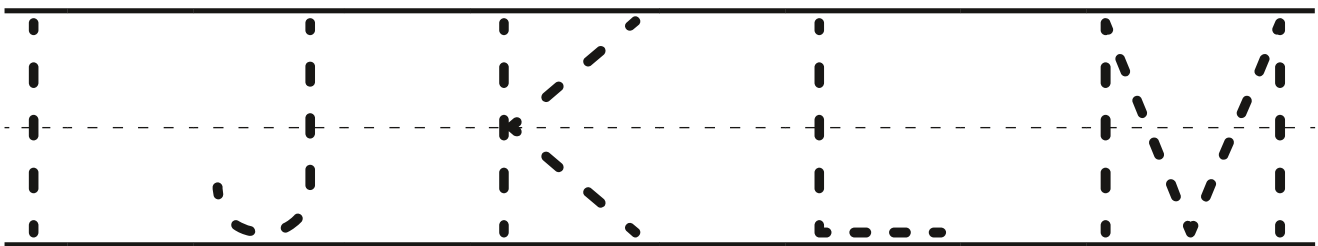
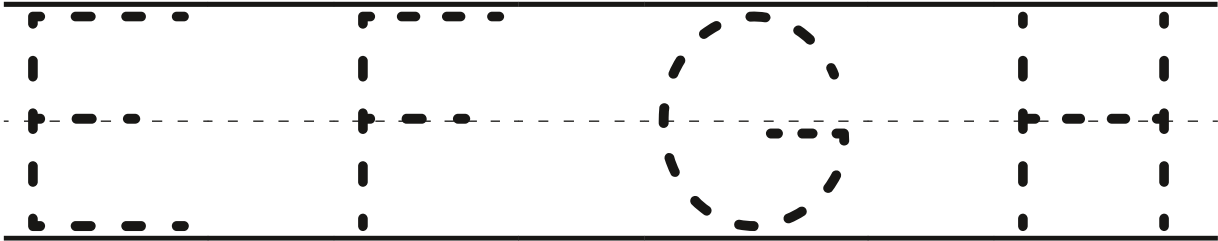
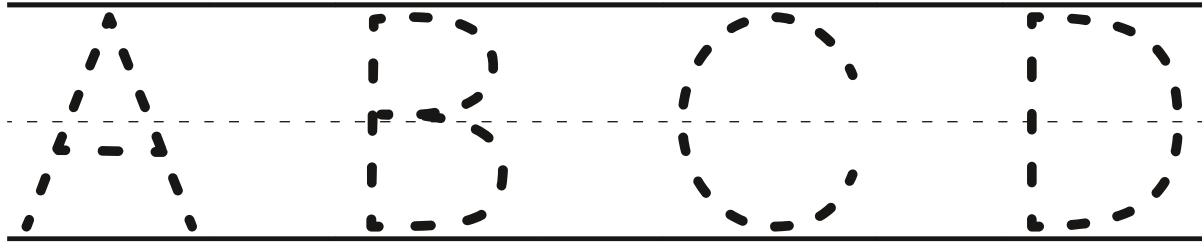

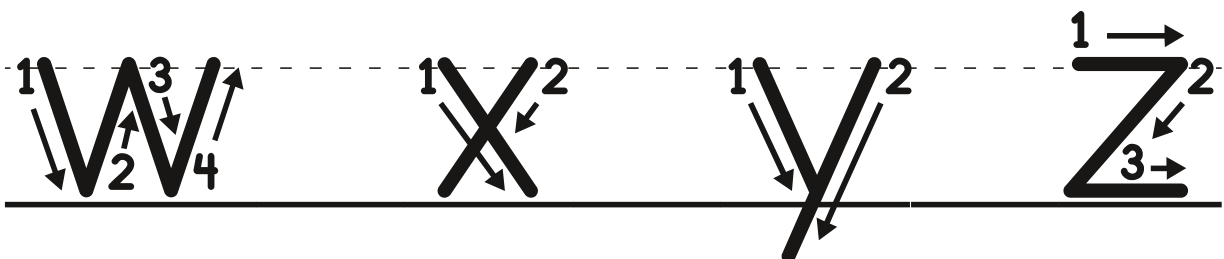
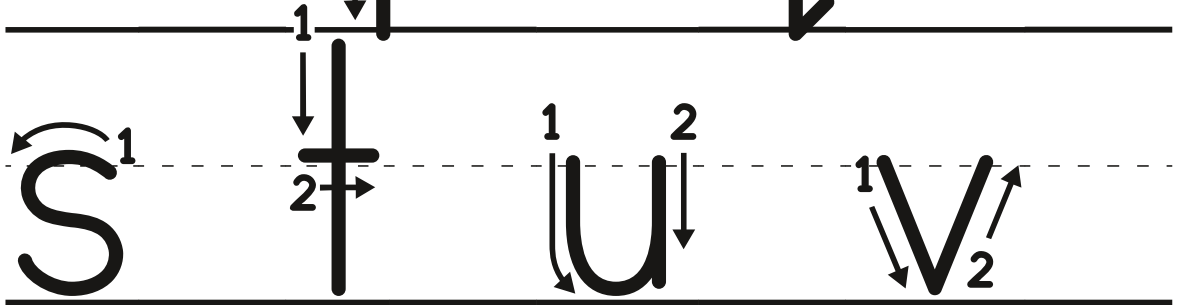
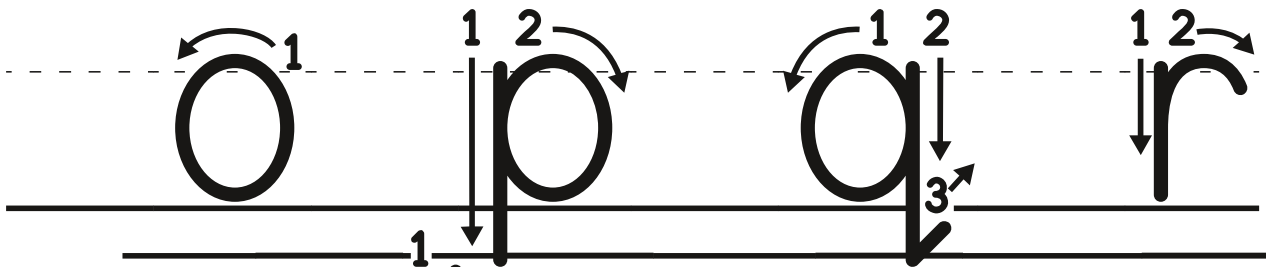
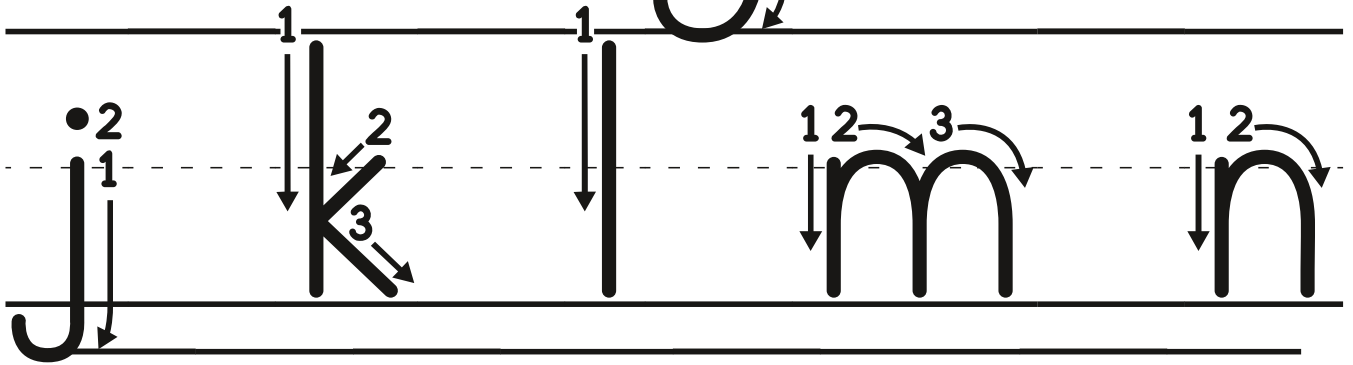
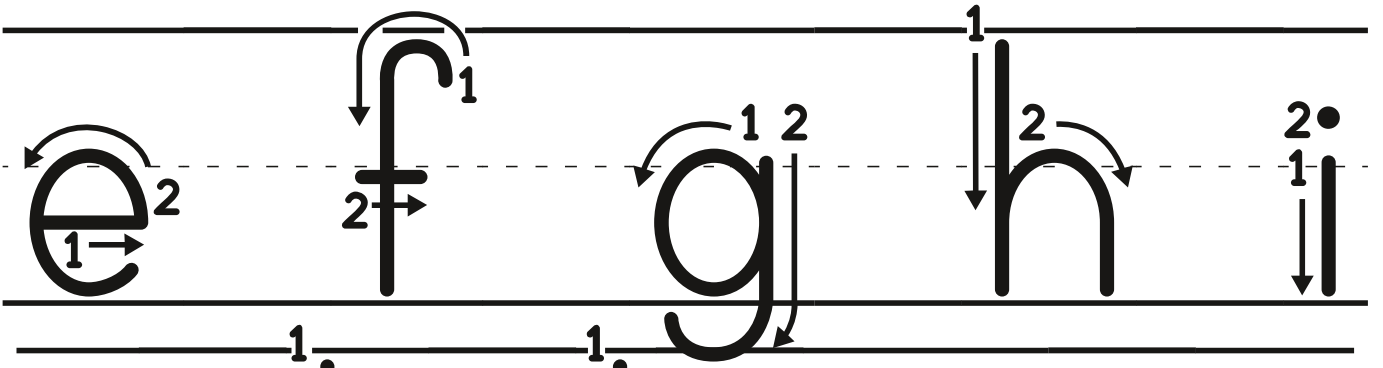
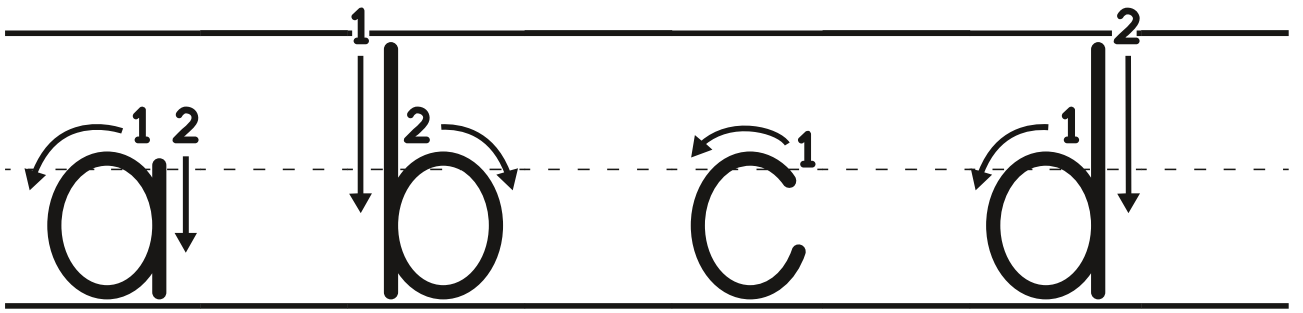

o o o o

s t u v

w x y z

o o o t

s t u v

w x y z

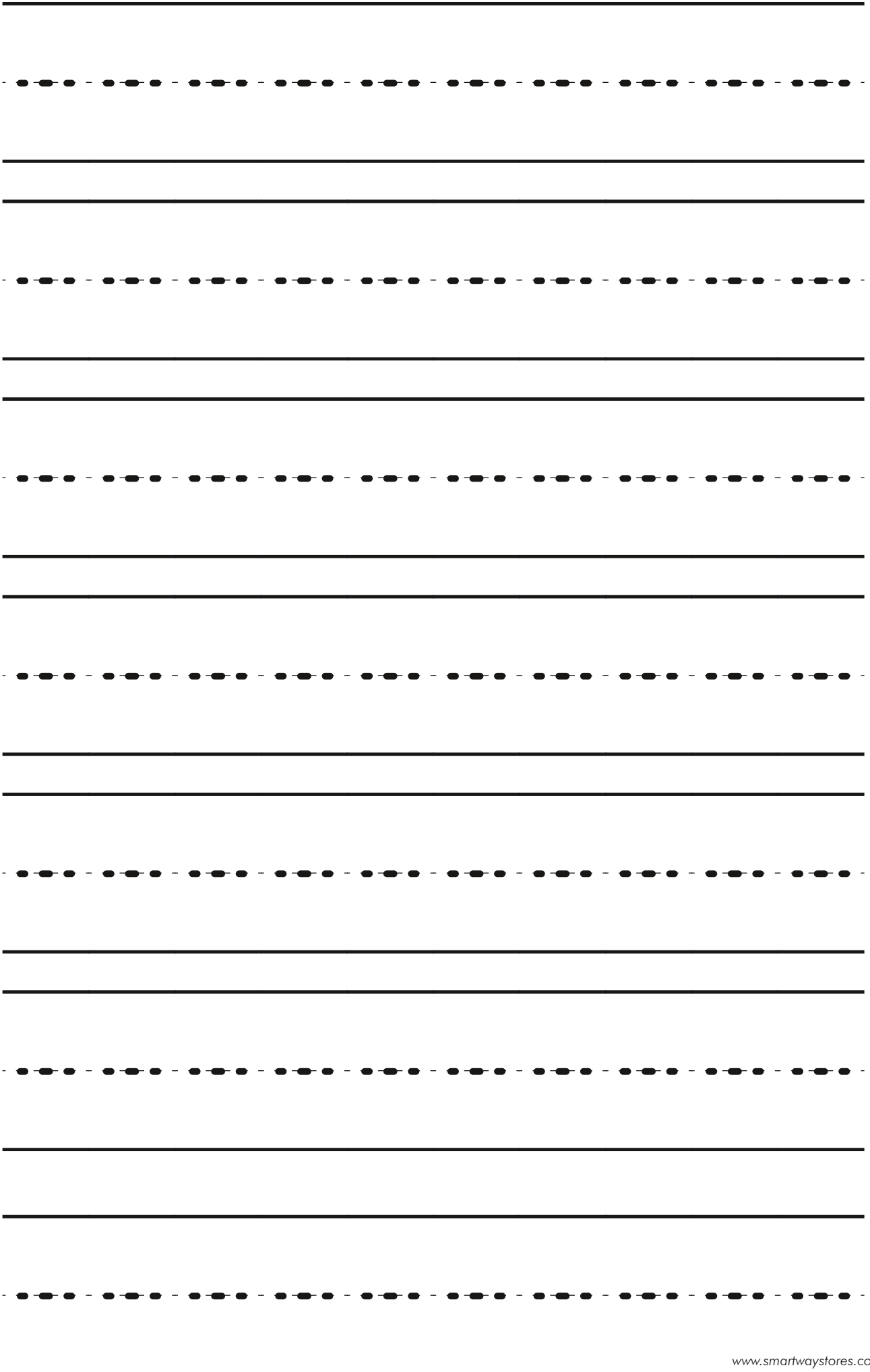

Other Relevant Resources

Teaching numbers to your preschoolers? Check out these resources

- ✓ Engage preschoolers with enjoyable number-learning resources
 - ✓ Interactive activities to enliven number education
- Simplify teaching with ready-made resources, allowing teachers to focus solely on student mastery

Counting 0-10
Winter Theme - Snowflakes

Bundle
3 Decks
Level 1 - 3
32 Cards

How many snowflakes?
10 9 8

Drag snowflakes in ten frame. Drag the number in the adjacent to know how many snowflakes to drag.

Count the snowflakes in ten frame and drag the correct number in the adjacent.

6 4 5

SMART
Hosted at boomlearning

Counting (0 - 20)
Fall Theme: 8 Sets

How many apples?
8 7 6

How many candy corns?
14 15 13

0-10 11-20

How many acorns?
14 13 12

How many sunflowers?
5 7 6

SMART
Hosted at boomlearning

Counting 1 - 10
Fall Theme

Drag candy corns in ten frame in pumpkin to know how many candies.

Drag candy corns in ten frame and drag the correct number in the pumpkin.

3

5 4 3

Level 2: 20 Cards

SMART
BOOM! CARDS

Add & Subtract to 5
K.OA.A.5

$0 + 2 =$

$1 + 3 =$

$2 + 1 =$

$3 + 0 =$

$0 - 2 =$

$2 - 1 =$

$3 - 3 =$

$3 - 0 =$

$1 - 2 =$

Printable & Editable
Task Cards

Other Relevant Resources

Teaching letters to your preschoolers? Check out these resources

- ✓ Engage preschoolers with enjoyable letter-learning resources
 - ✓ Interactive activities to enliven alphabet education
- Simplify teaching with ready-made resources, allowing teachers to focus solely on student mastery
- ✓ Reliable methods for letter proficiency from expert educators



A-Z Letter Booklets
26 Booklets Bundle

My Letter Book

26 Booklets x 12 pages -PDF

smart way

This advertisement features a yellow background with three sample letter booklets. The first shows the letter 'A' with a drawing of a kangaroo. The second shows the letter 'B' with a bear. The third shows the letter 'C' with a cat. Each booklet is titled 'My Letter Book'.



Letters & Pictures
Posters

5 Pictures with each letter

155+ pages

smart way

This advertisement has a blue header and shows several colorful posters. Each poster features a letter (e.g., 'Aa') and five corresponding illustrations (e.g., an apple, an avocado, acorns, an ambulance, and an alligator). A blue callout box highlights '5 Pictures with each letter' and '155+ pages'.

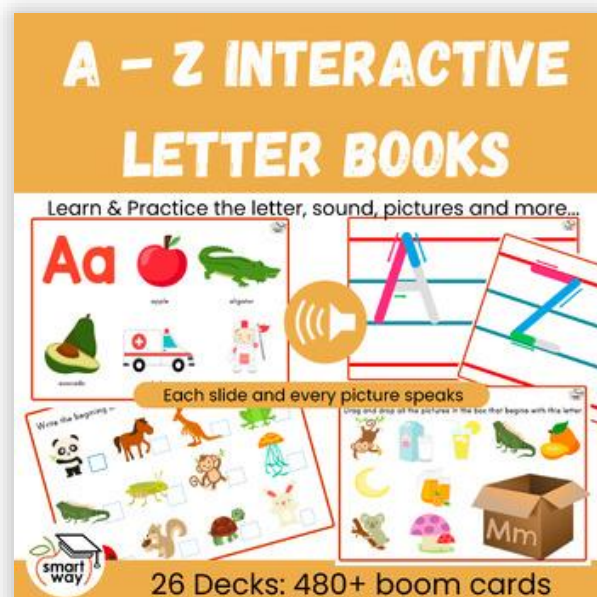

A - Z INTERACTIVE
LETTER BOOKS

Learn & Practice the letter, sound, pictures and more...

Each slide and every picture speaks

26 Decks: 480+ boom cards

smart way

This advertisement has an orange background. It shows a sample slide for the letter 'Aa' with an apple and an alligator. Below it, there are two activity cards: one for writing the beginning of words and another for identifying words that start with a letter. A speaker icon indicates audio functionality.



LETTERS A - Z Bundle

Practice the letter name, sound, and pictures

 Aa Bb Cc Dd	 Gg Ee Hh Ff	 Ll Kk Ii Jj
 Mm Pp Nn Oo	 Ss Qq Tt Rr	 Ww Xx Uu Vv Yy Zz
Cc Aa Dd	Pp Nn Oo Mm	Vv Yy Zz Ww Uu Xx

270 CARDS, 6 DECKS

smart way

This advertisement has a teal background. It displays a grid of cards for practicing letter names, sounds, and pictures. The cards are arranged in three rows and three columns. A speaker icon is in the bottom right corner.