

Thankyou



I want to take a moment to thank you for the recent purchase. It is my pleasure to assist you. By downloading this resource, you are agreeing to the term listed below.

You may

- Use this resource at home with your child or students.
- Use this resource with multiple students in a classroom/tutoring setting.
- Share the source of this resource with your colleagues by directing them to the store to get their own copies

You may not

- You may not share it or put it on internet.
- You may not sell or distribute it in any format/manner.

Copyright©2024 Smart Way
- All rights reserved.
Permission to use for a single
classroom use only (for both
digital and printable)

Get Access to Our Exclusive Freebie Library

Subscribe and get access to our exclusive freebie library and stay updated... [click here](#)

Let's Connect



Credits

Fonts



Illustrations



Writing Sheets

Uppercase letters

CW / HW Date: _____

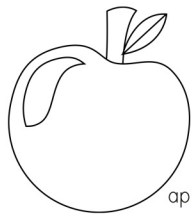
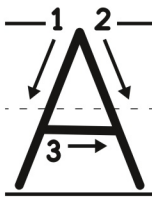

A A A A

A A A A

A

CW / HW Date: _____

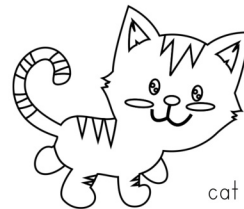
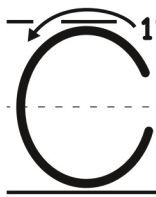

C C C C

C C C C

C

CW / HW Date: _____

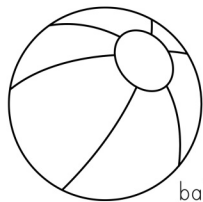
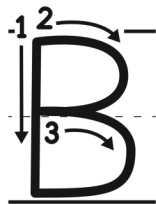

B B B B

B B B B

B B B B

CW / HW Date: _____

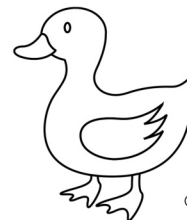
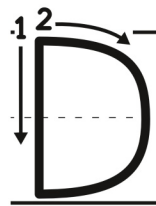

D D D D

D D D D

D D D D



Name: _____

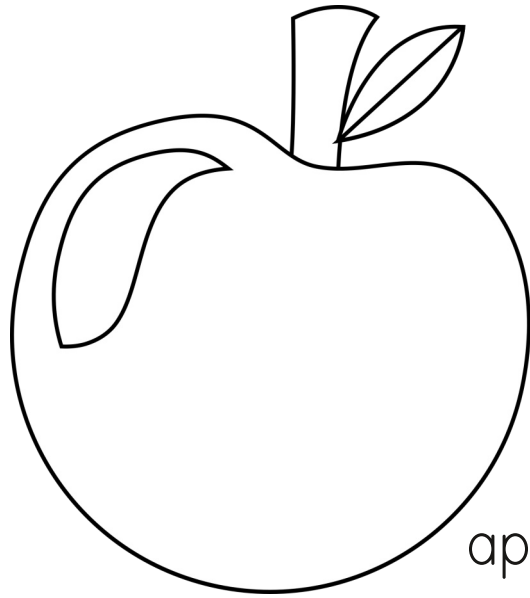
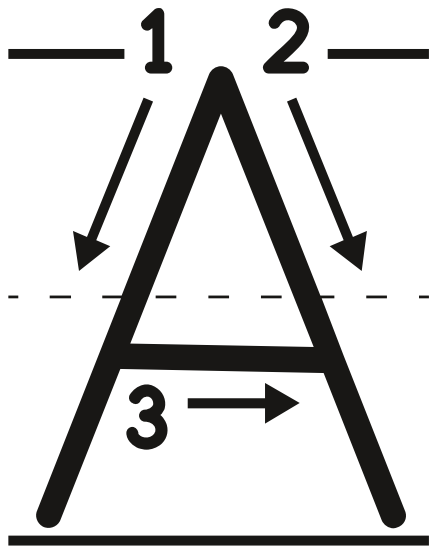

apple

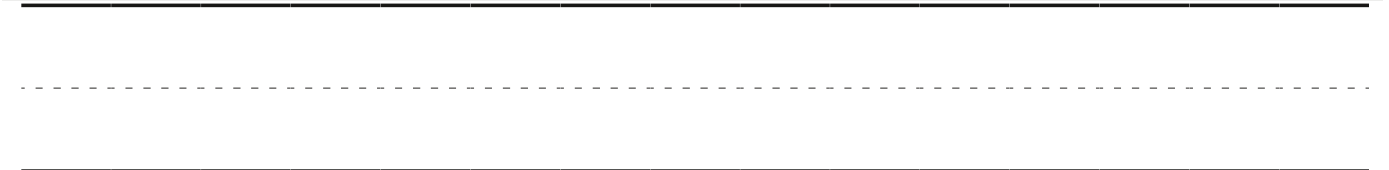
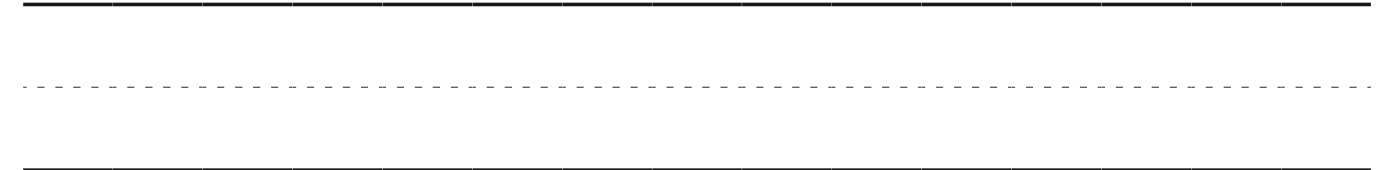
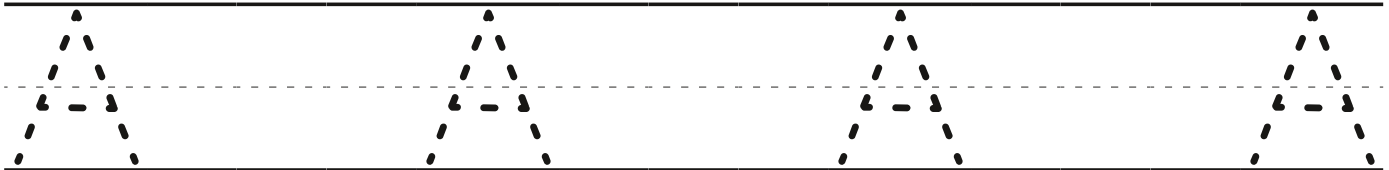
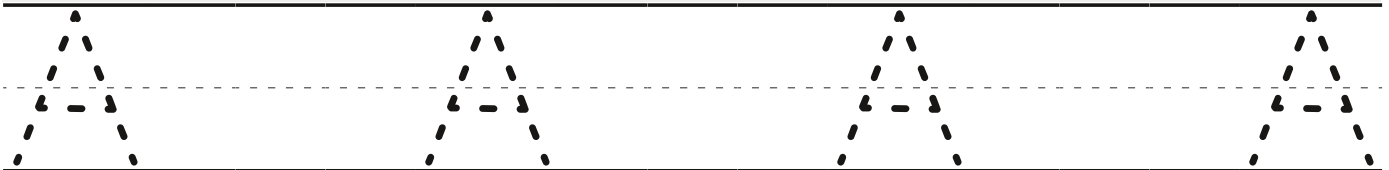
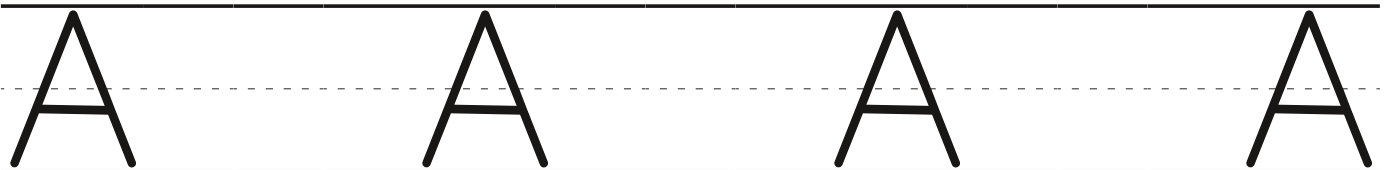

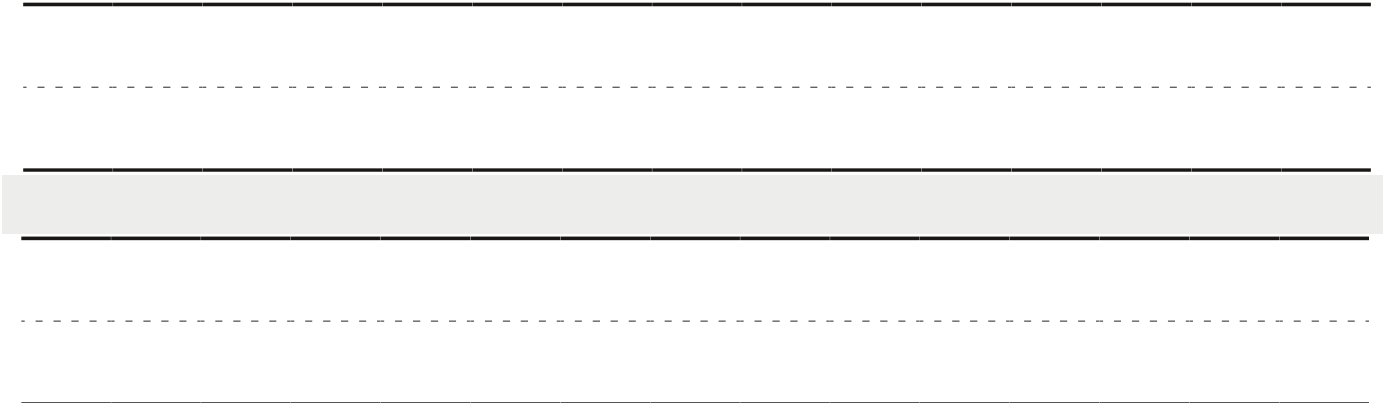
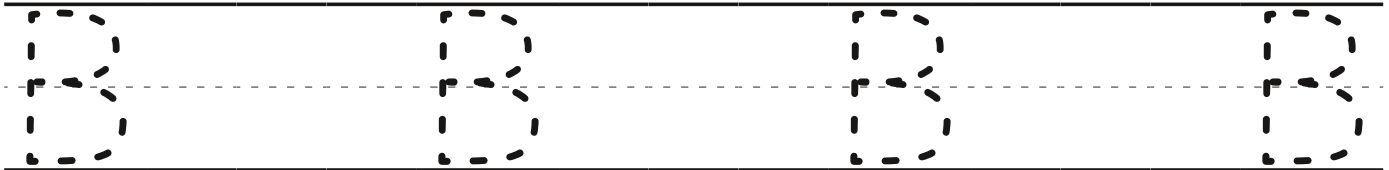
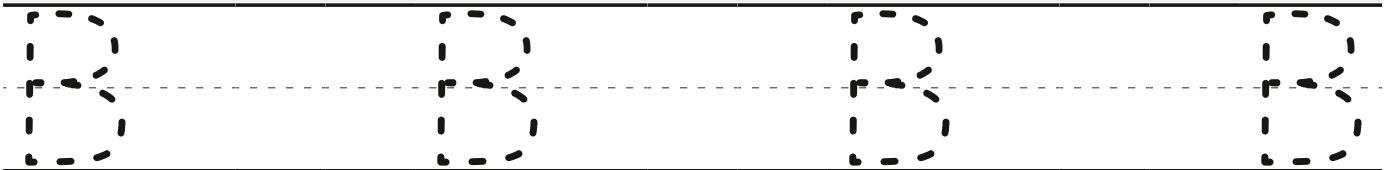
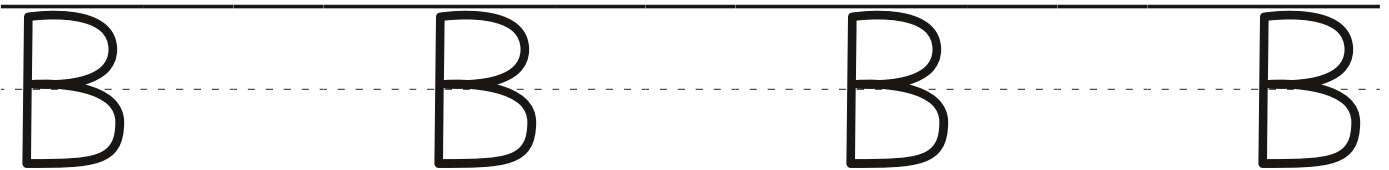
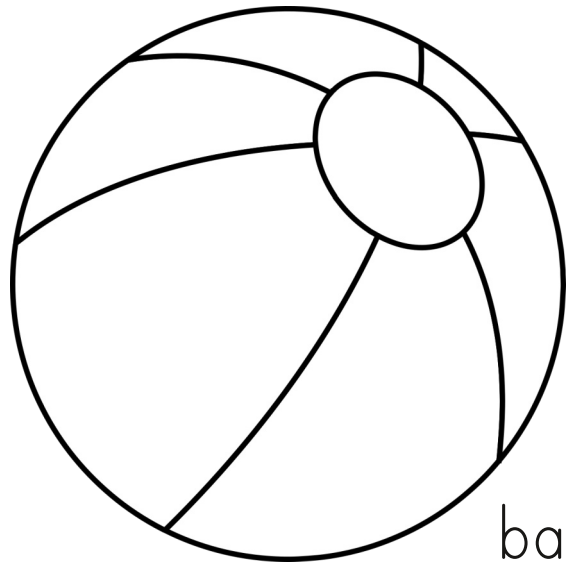
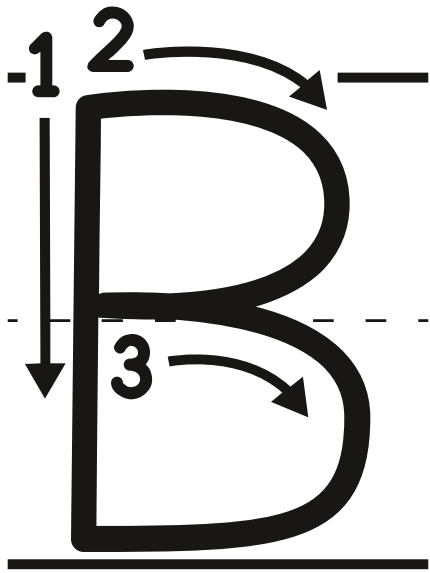

CW / HW

Date: _____

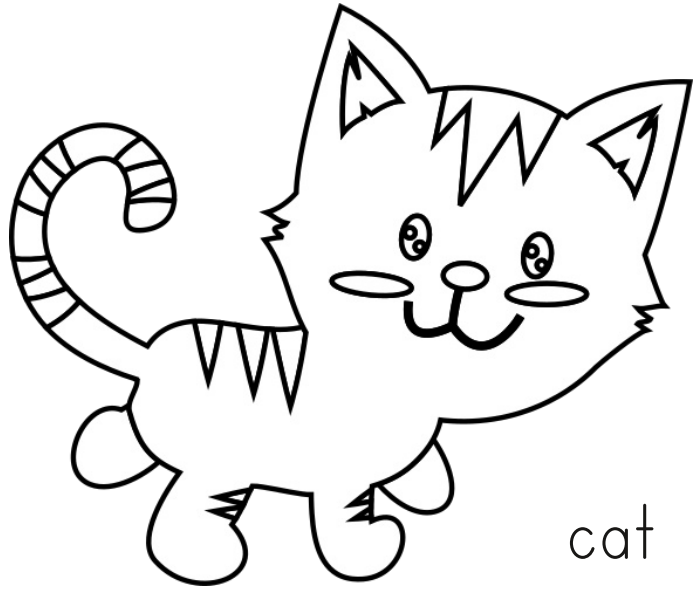
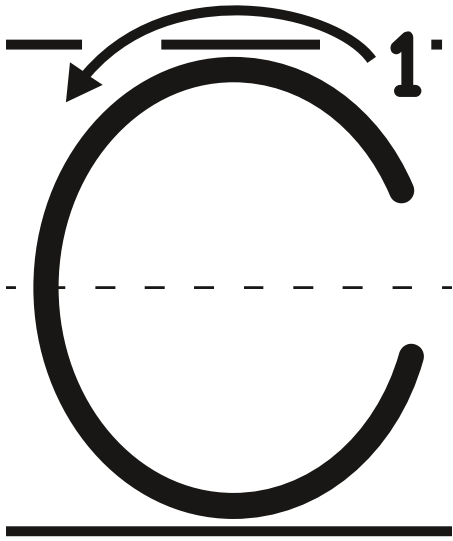

cat

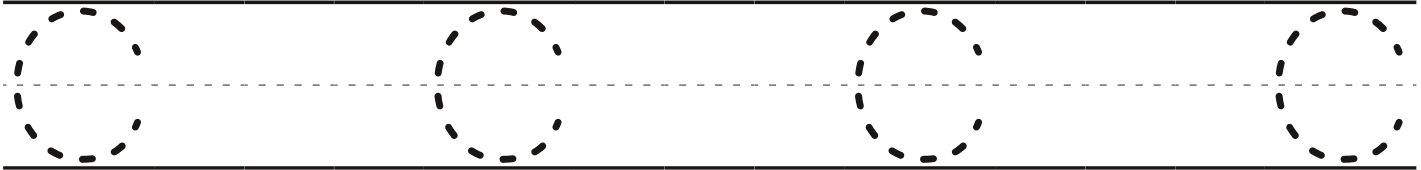
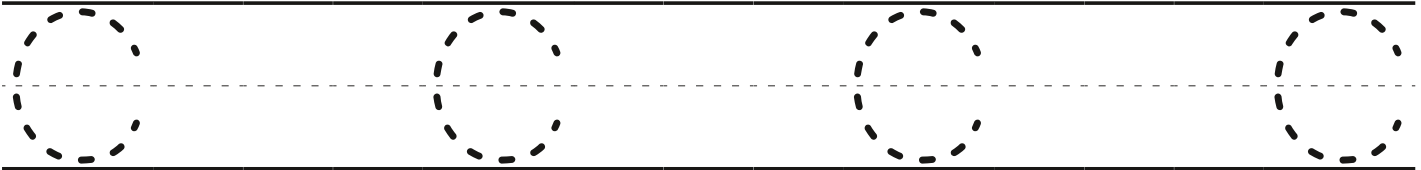
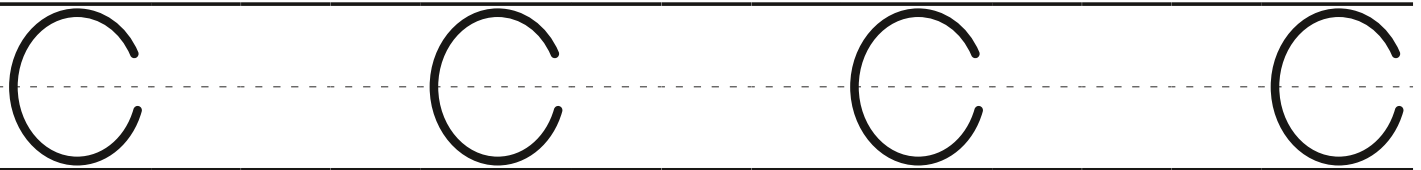

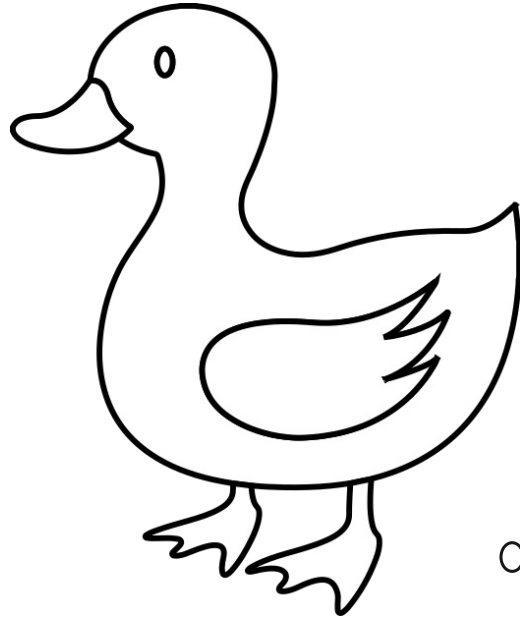
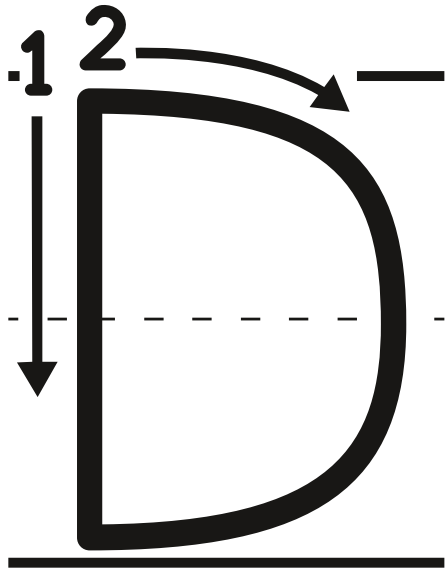

duck

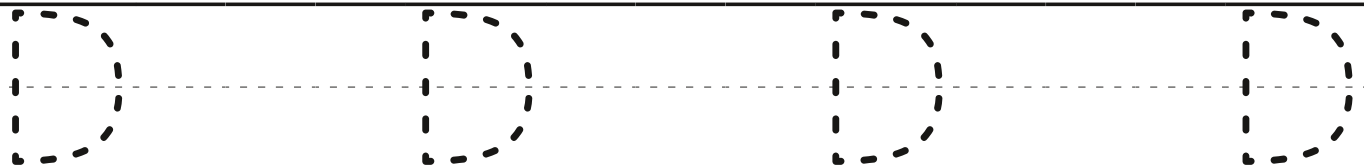
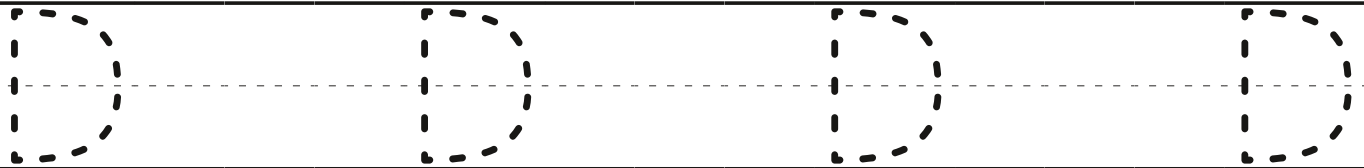
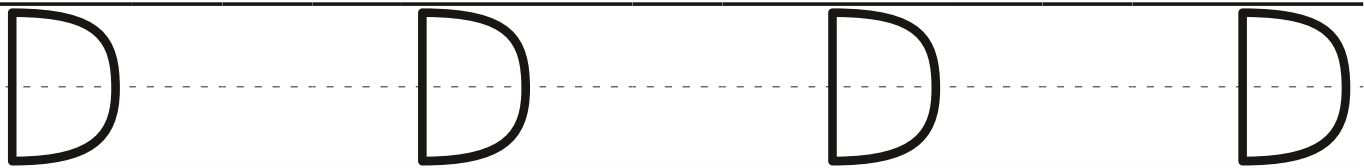

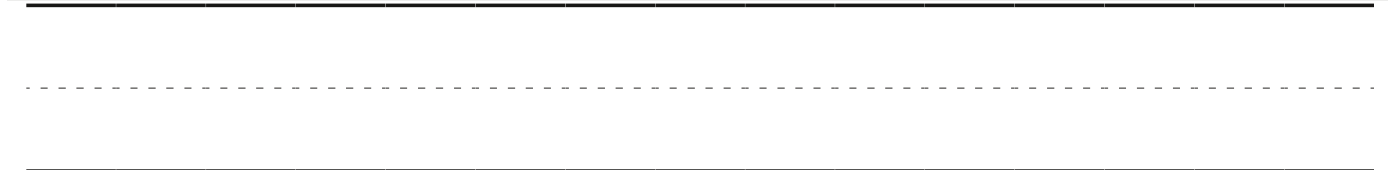
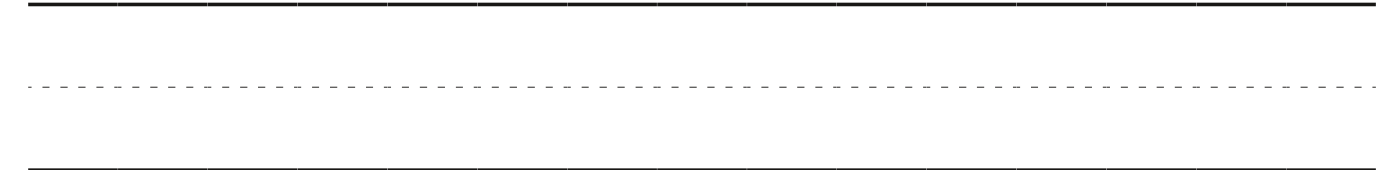
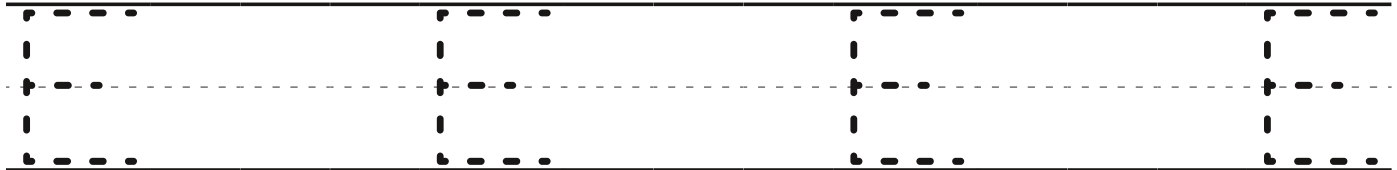
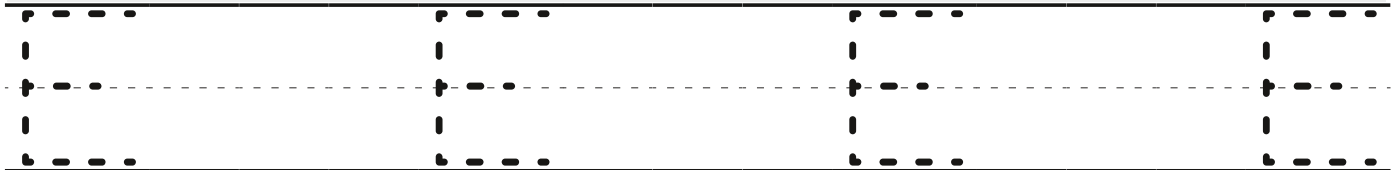
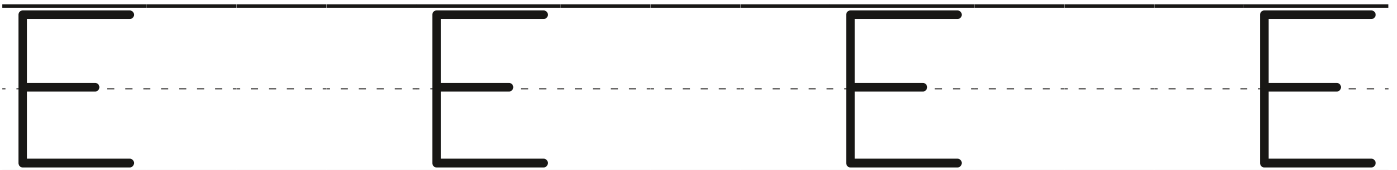
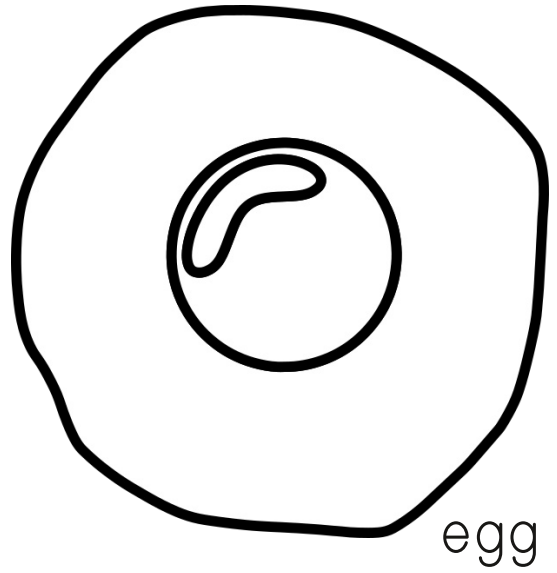
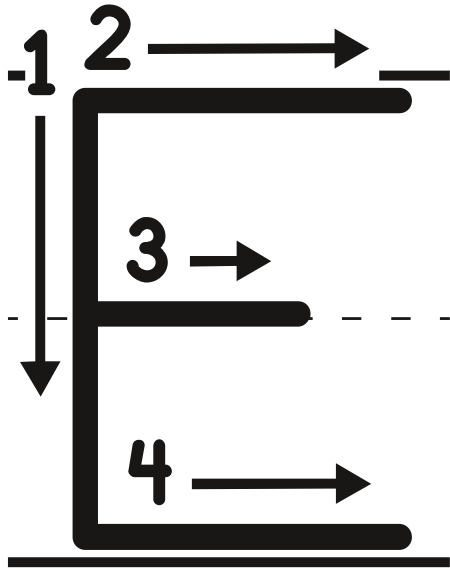

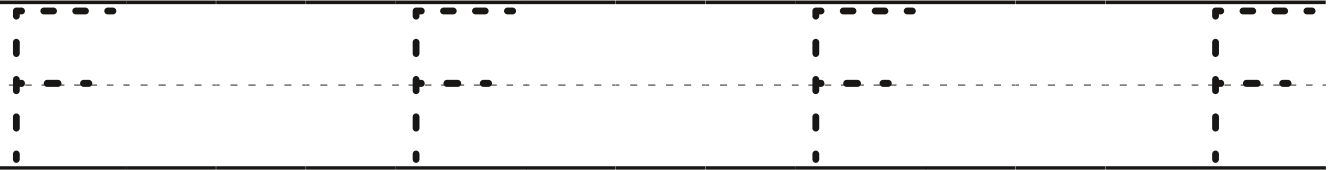
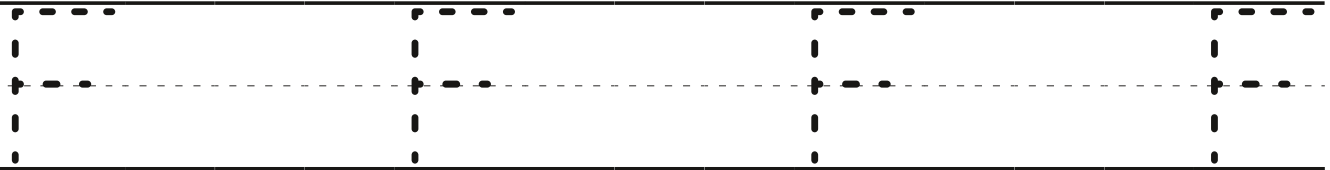
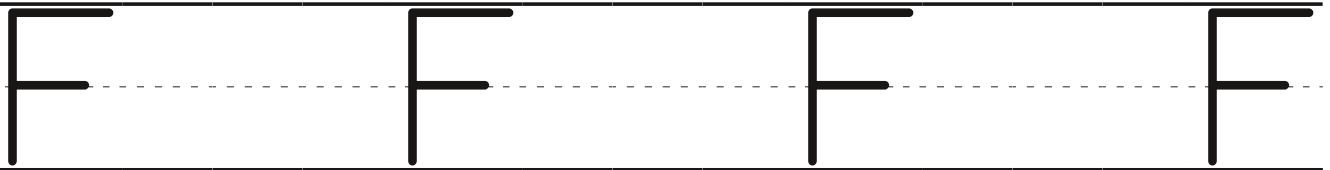
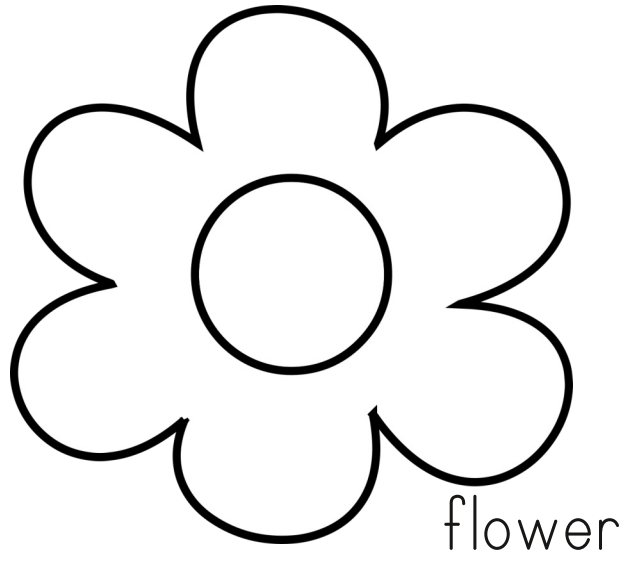
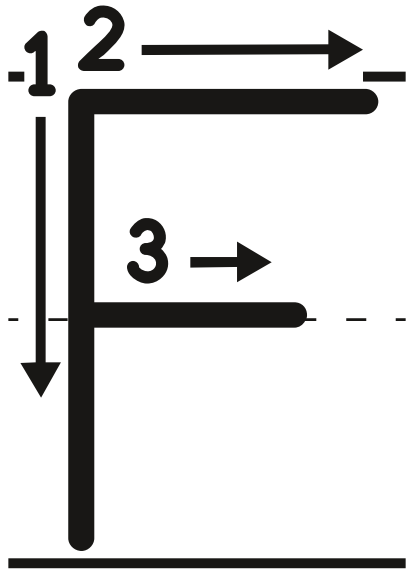

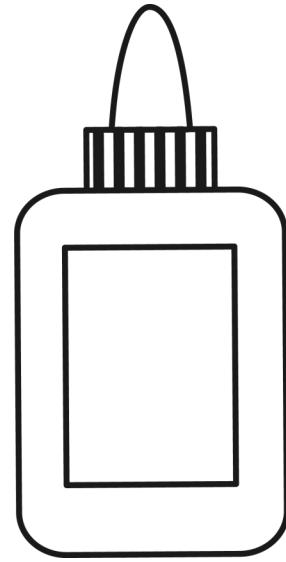
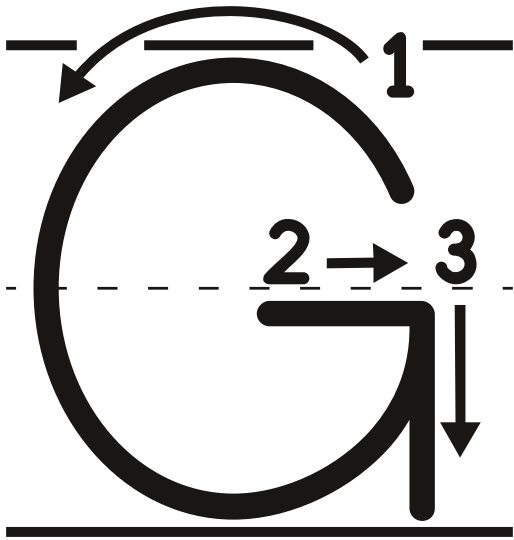

glue

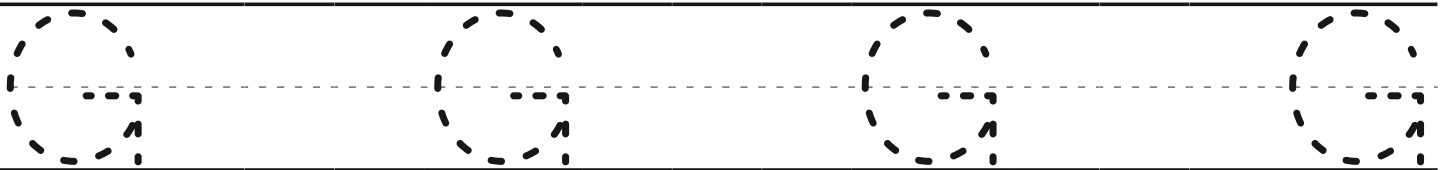
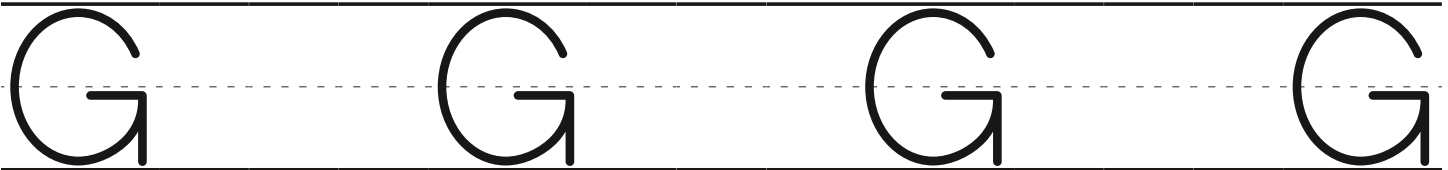

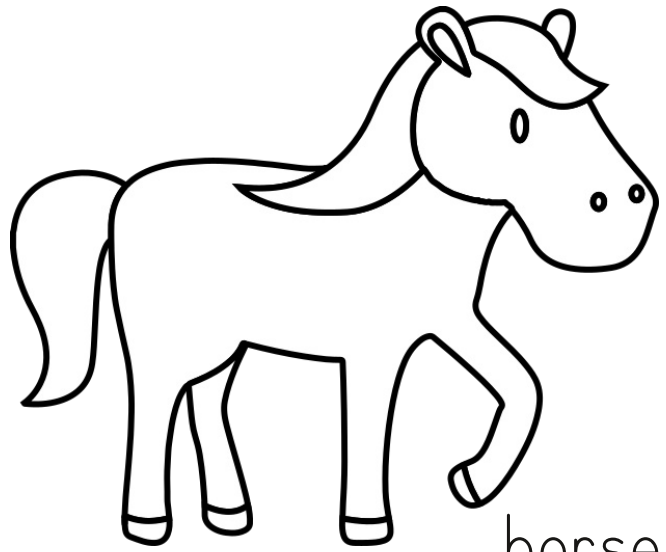
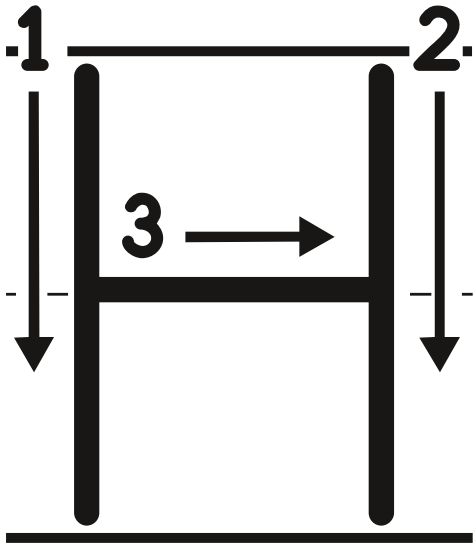

horse

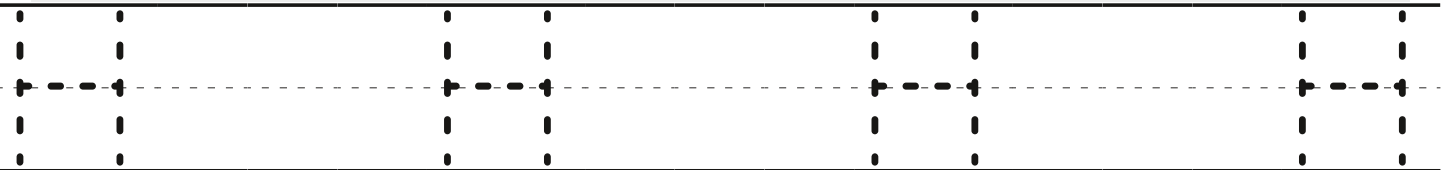
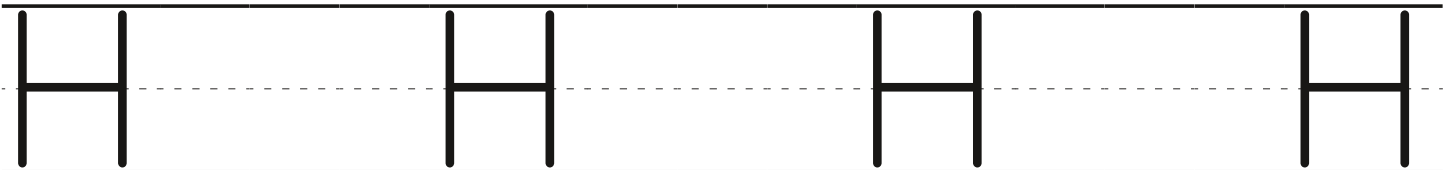

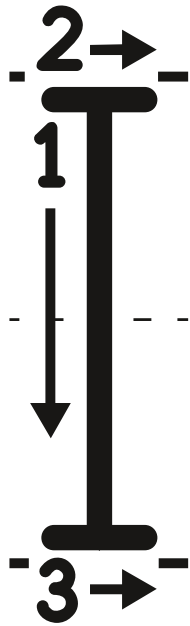

ice cream

Handwriting practice lines consisting of four rows. Each row has a solid top line, a dashed middle line, and a solid bottom line. The first two rows include vertical bars at the beginning and end of each line, and a dotted uppercase letter 'I' for tracing. The last two rows are blank for independent practice.

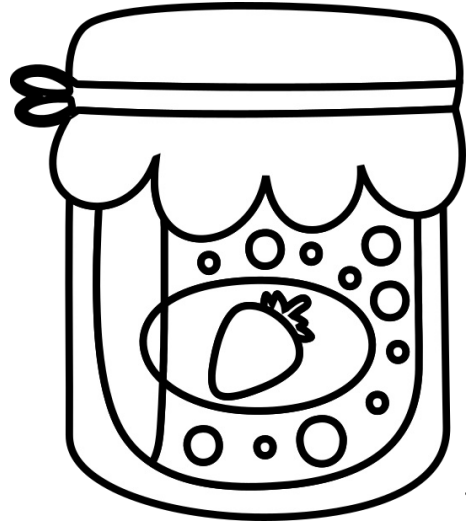
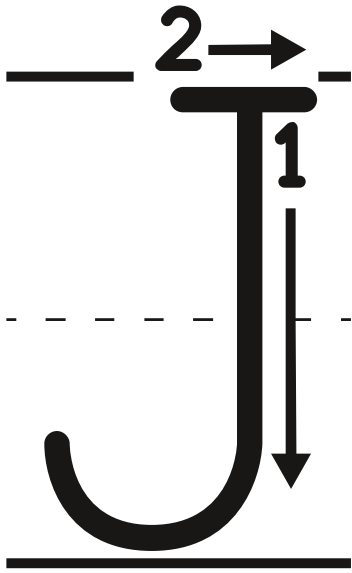

jam

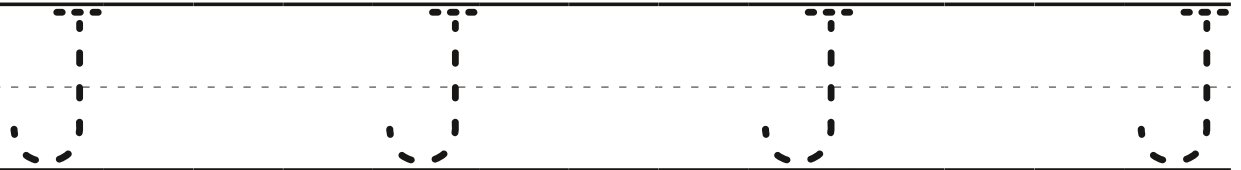
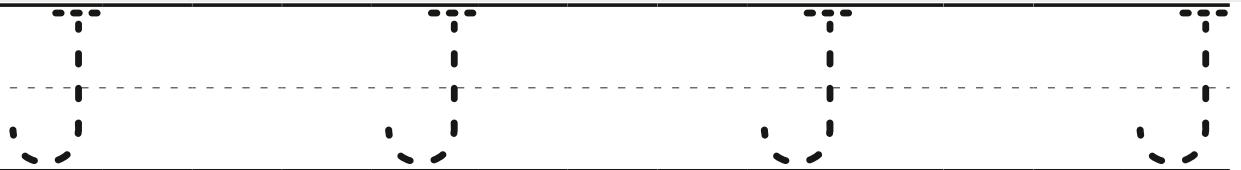
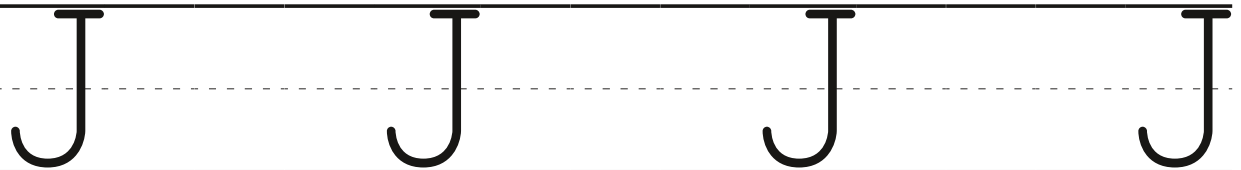

CW / HW

Date: _____

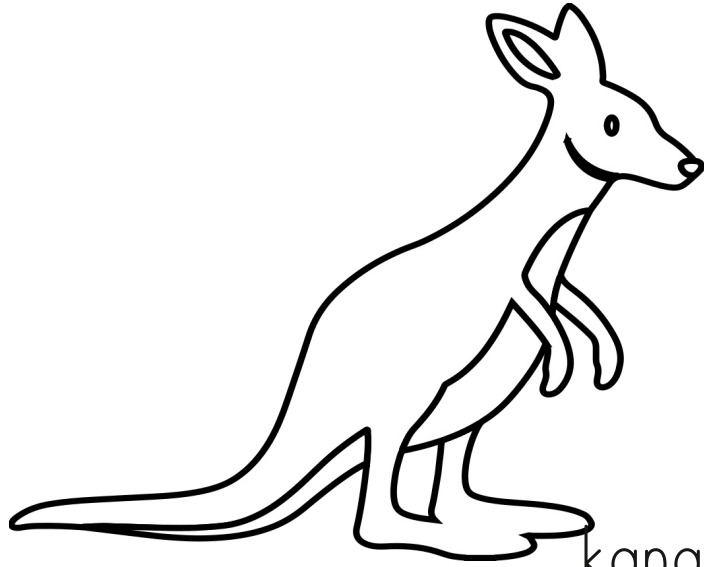
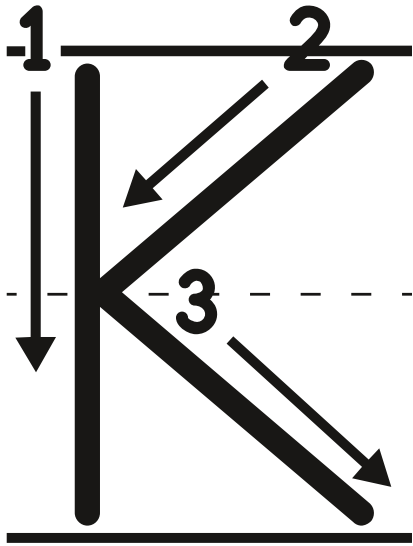

kangaroo

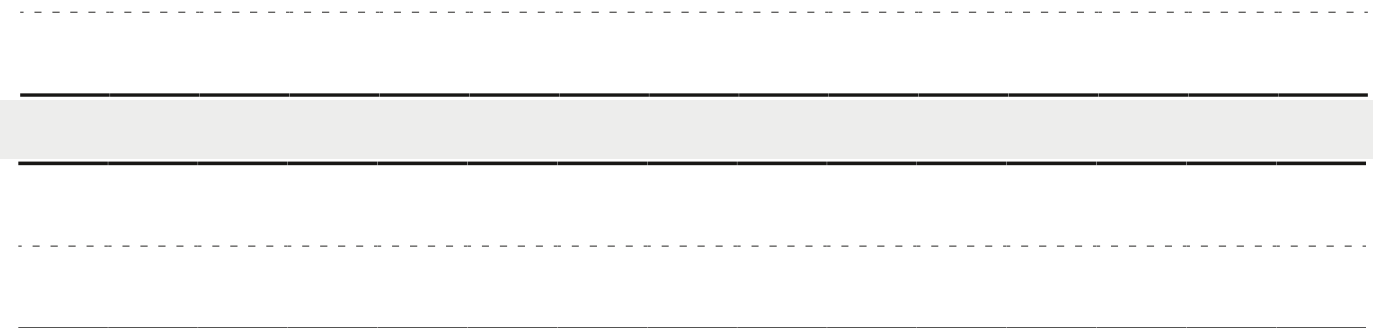
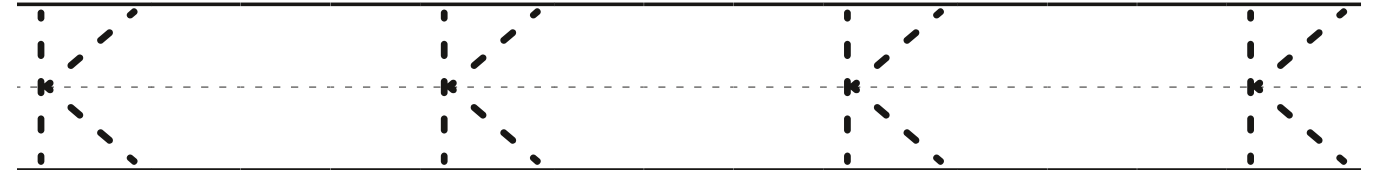
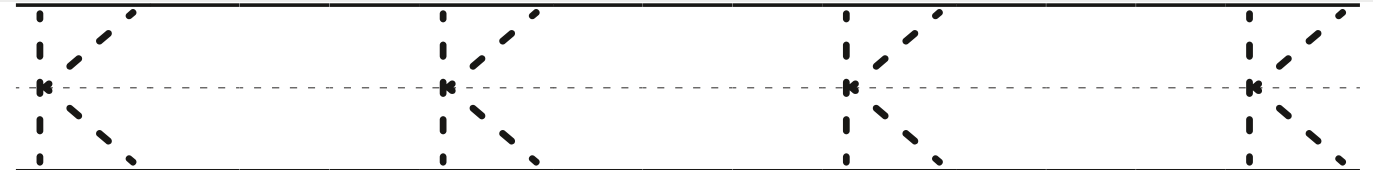
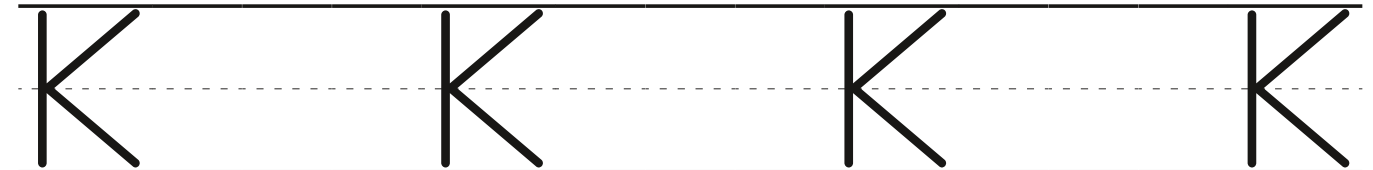

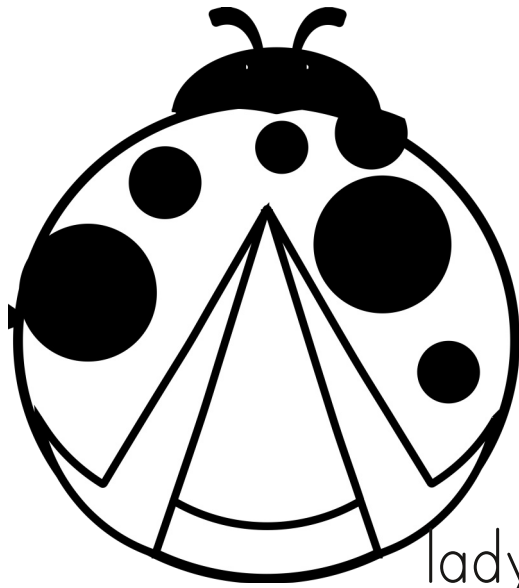
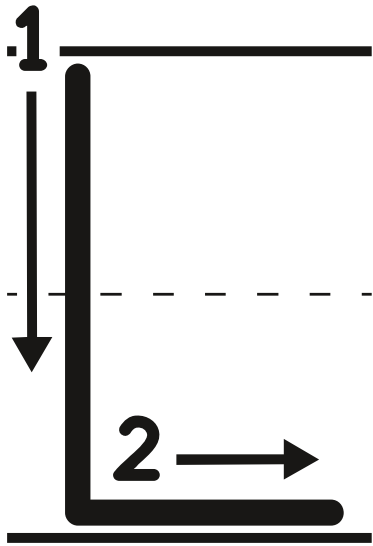

lady bug

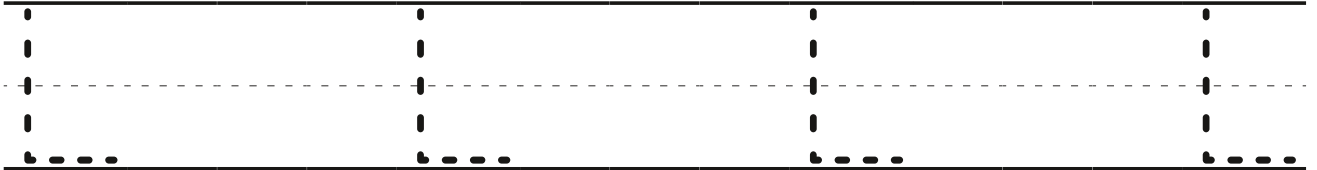
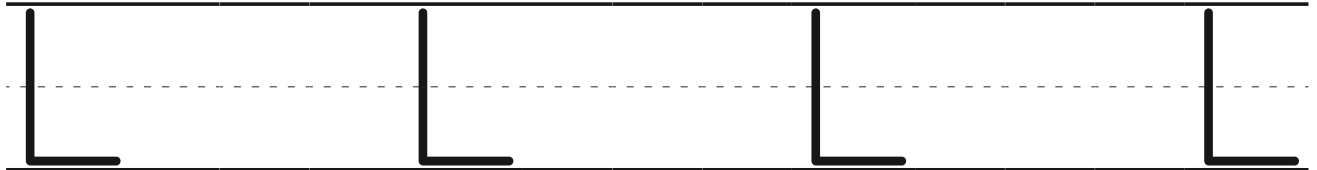

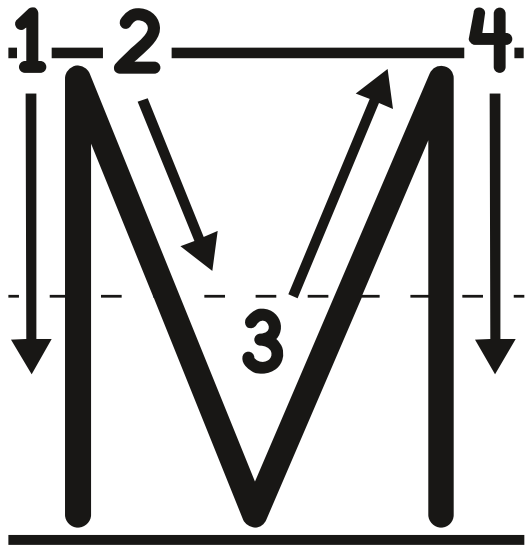

monkey

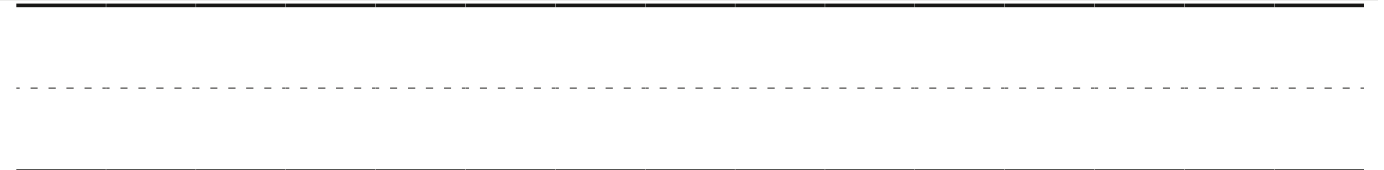
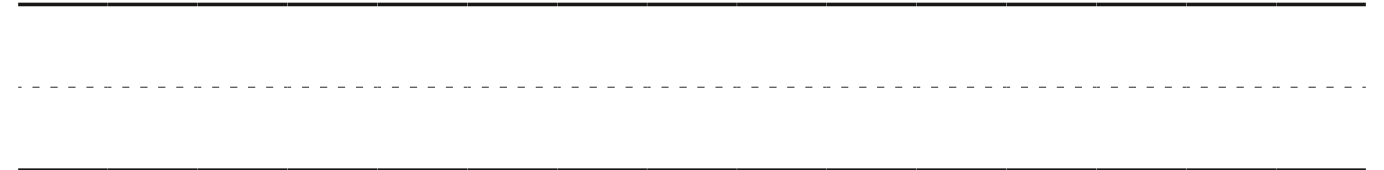
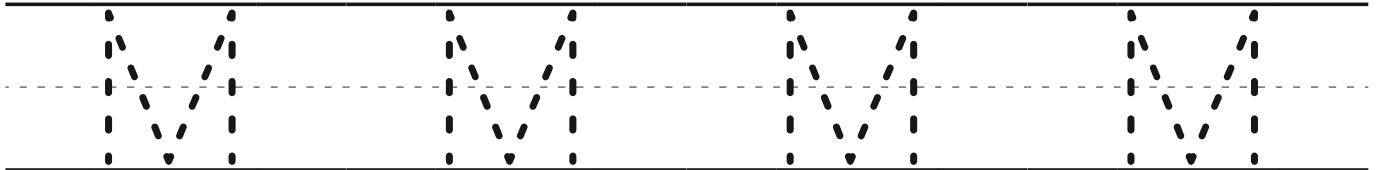
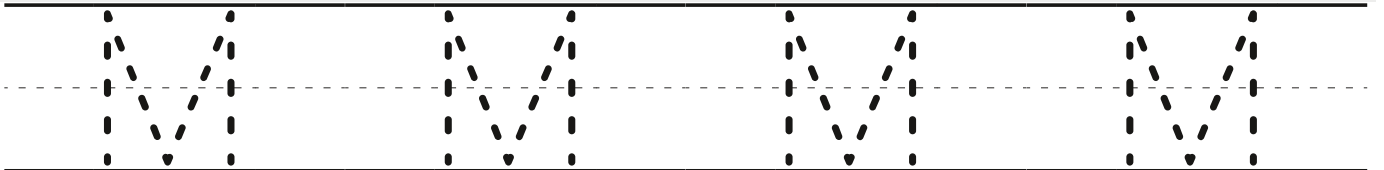
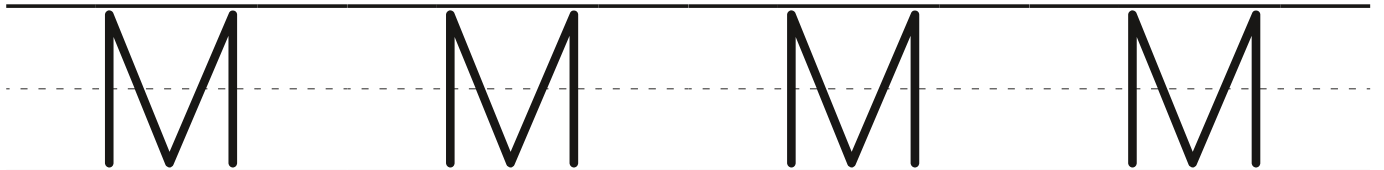

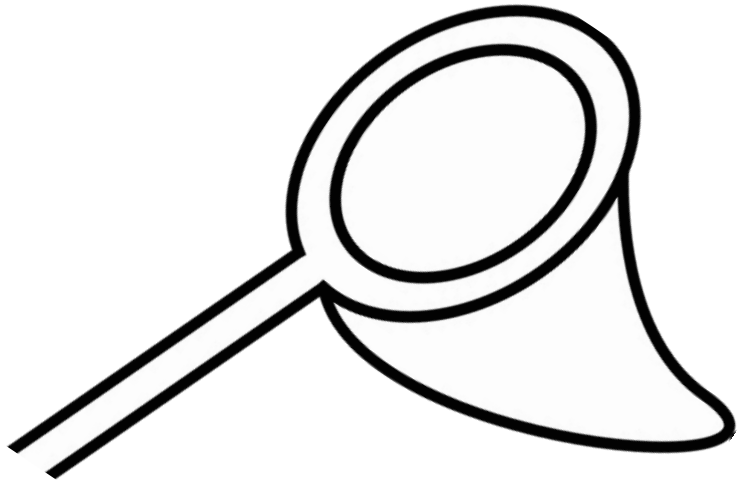
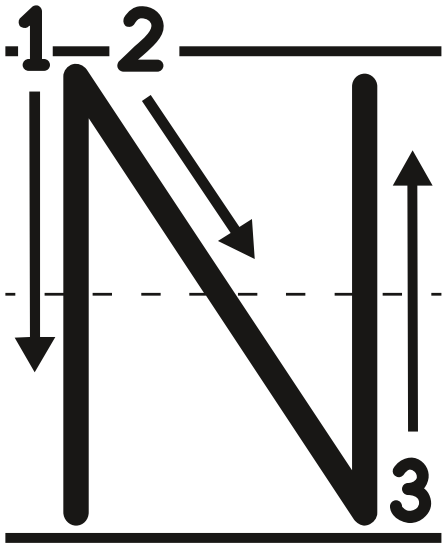

net

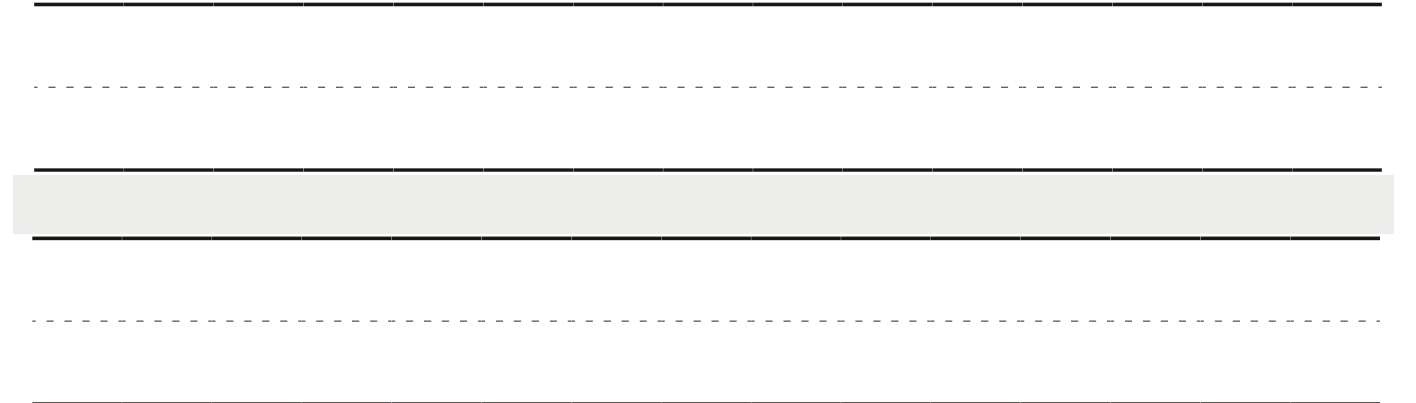
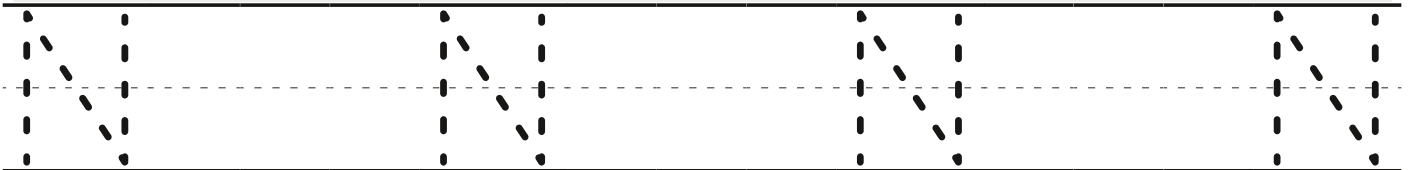
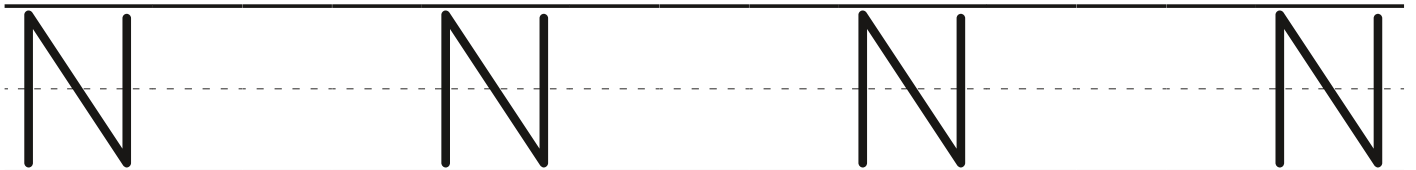

CW / HW

Date: _____

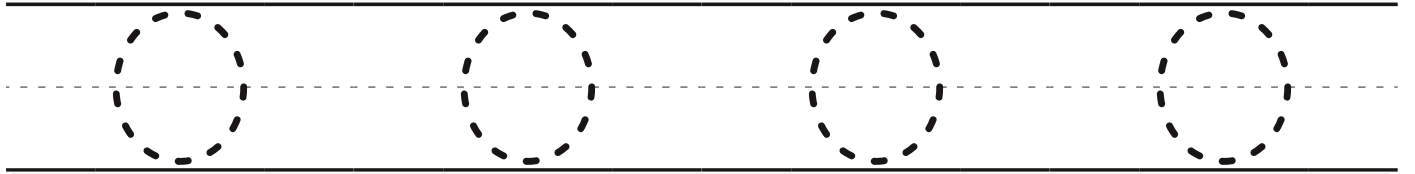
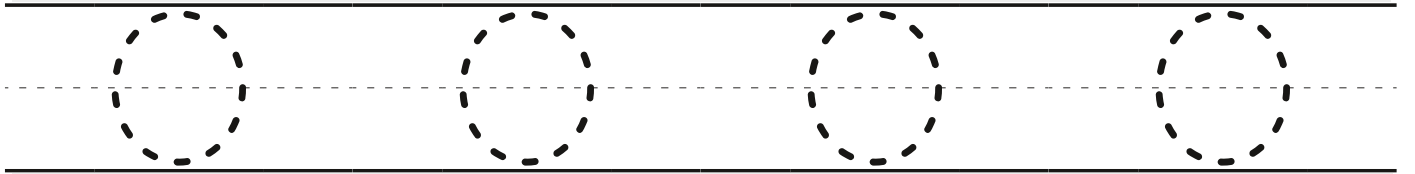
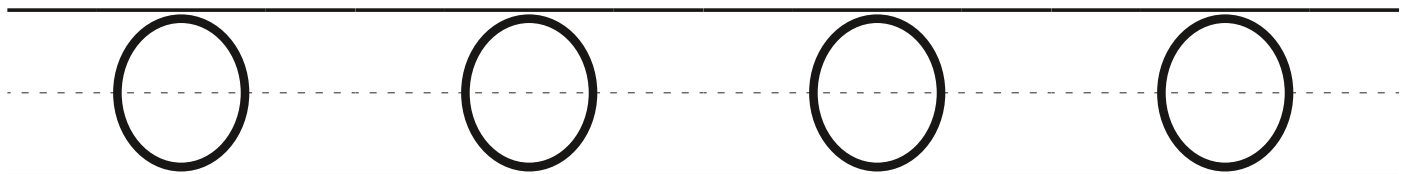
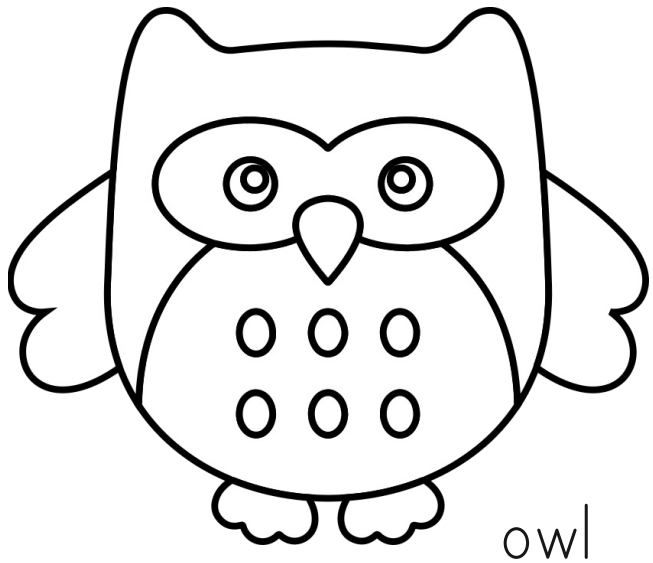
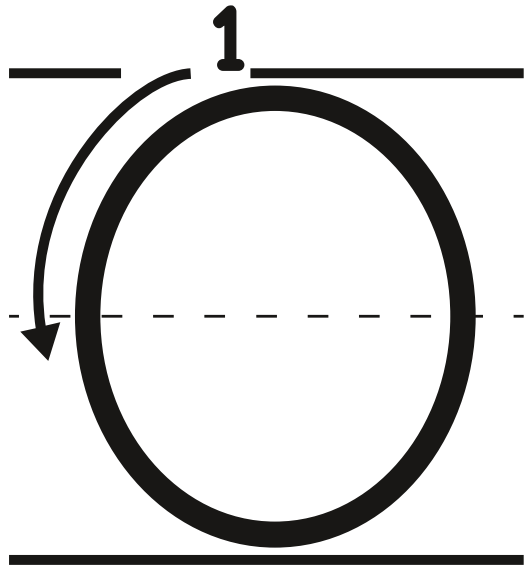

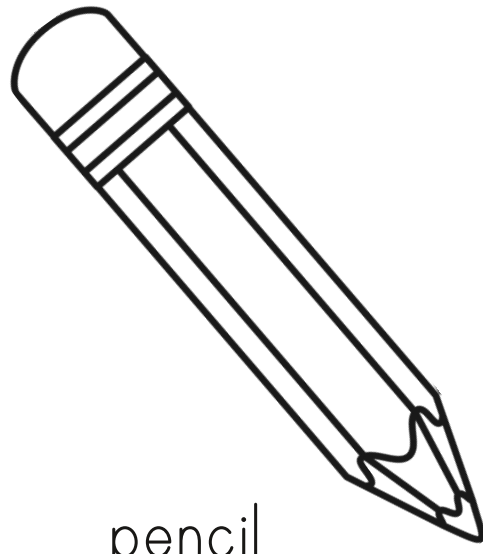
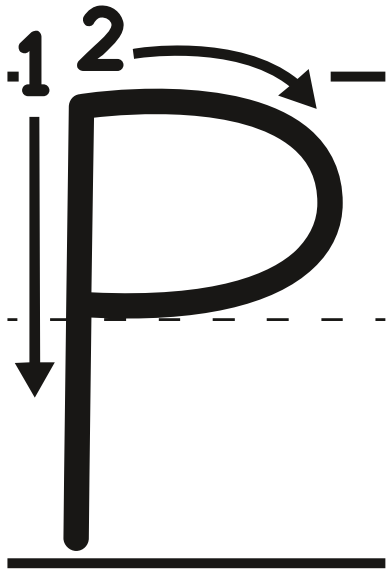

pencil

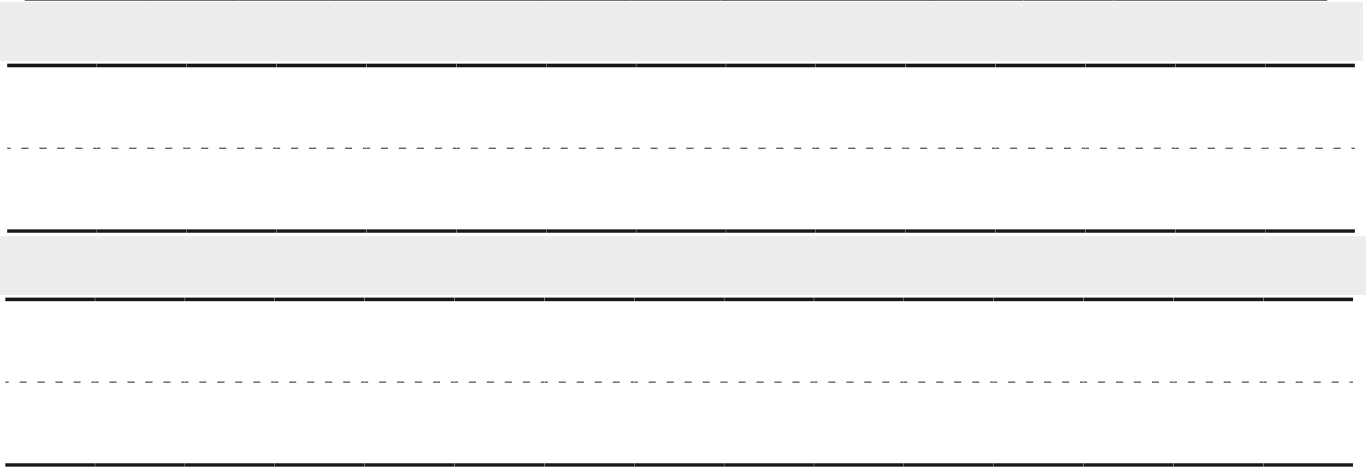
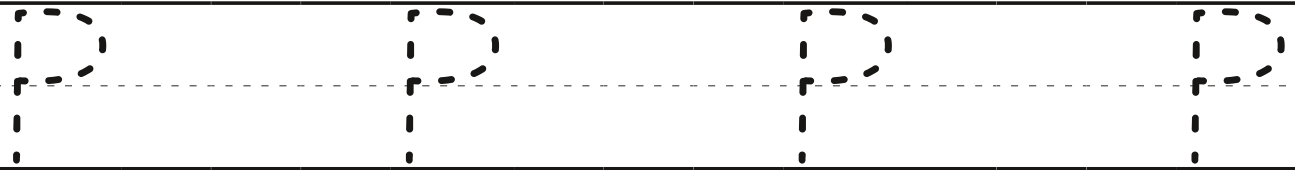
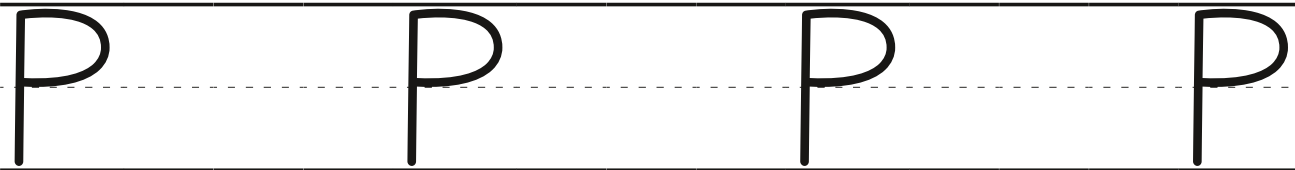

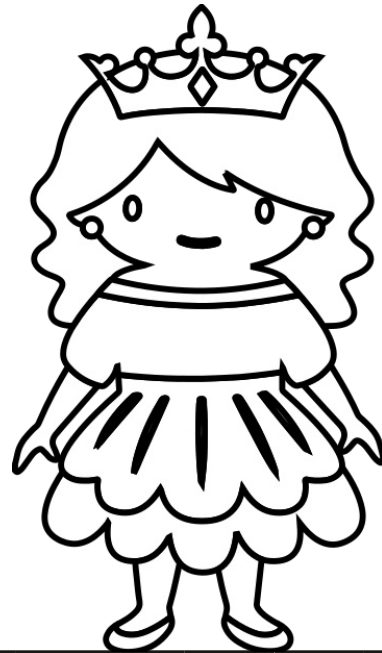
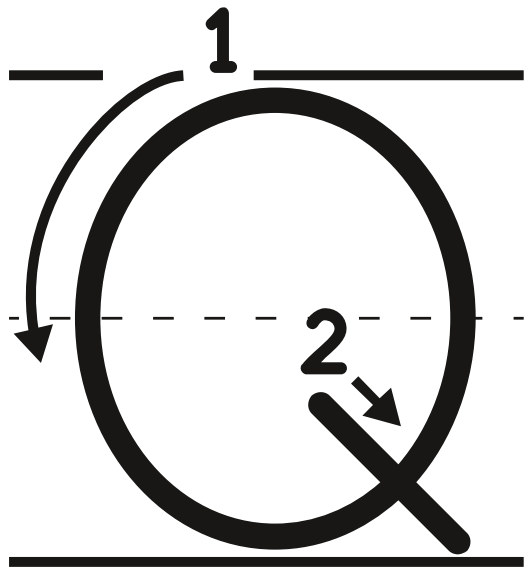

queen

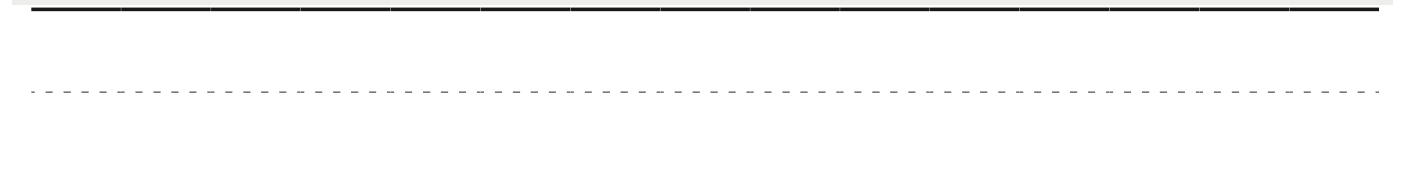
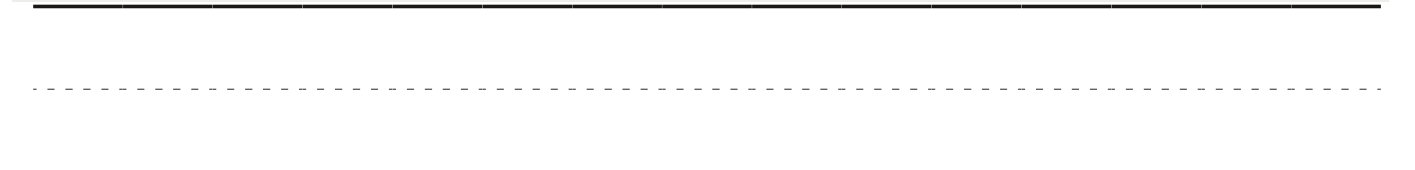
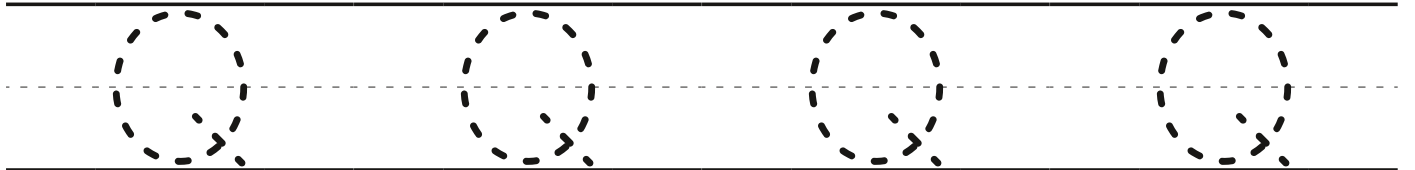
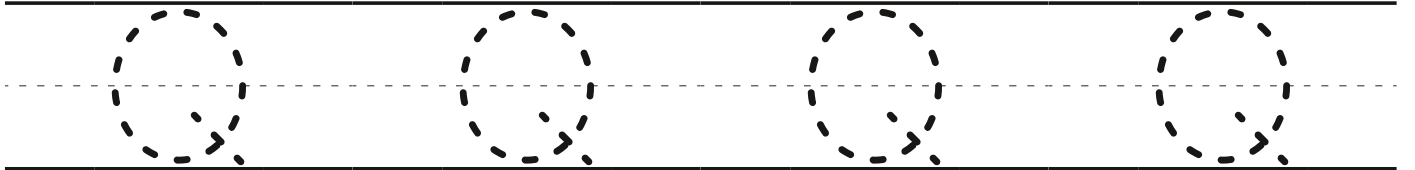
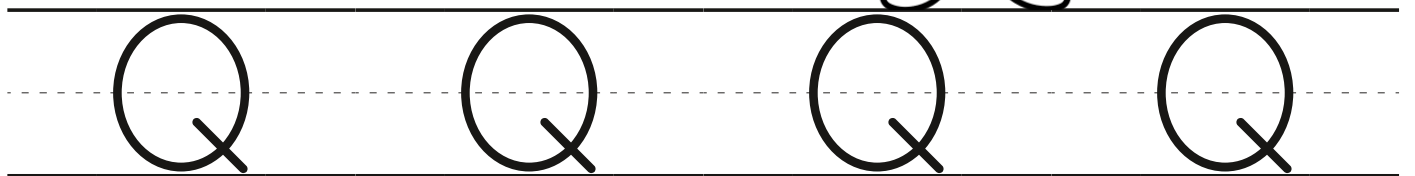

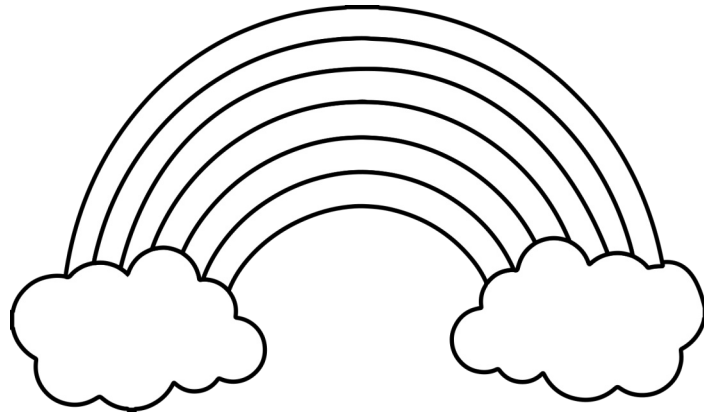
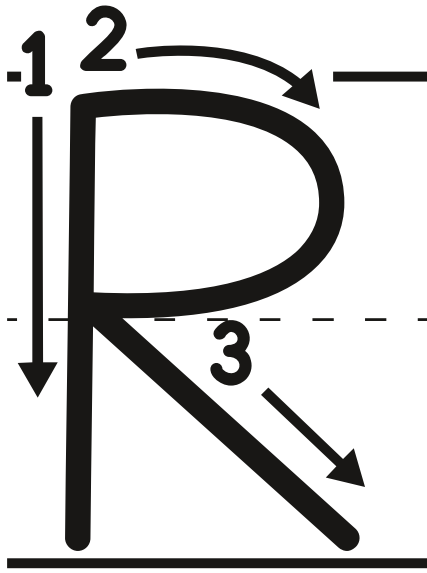

rainbow

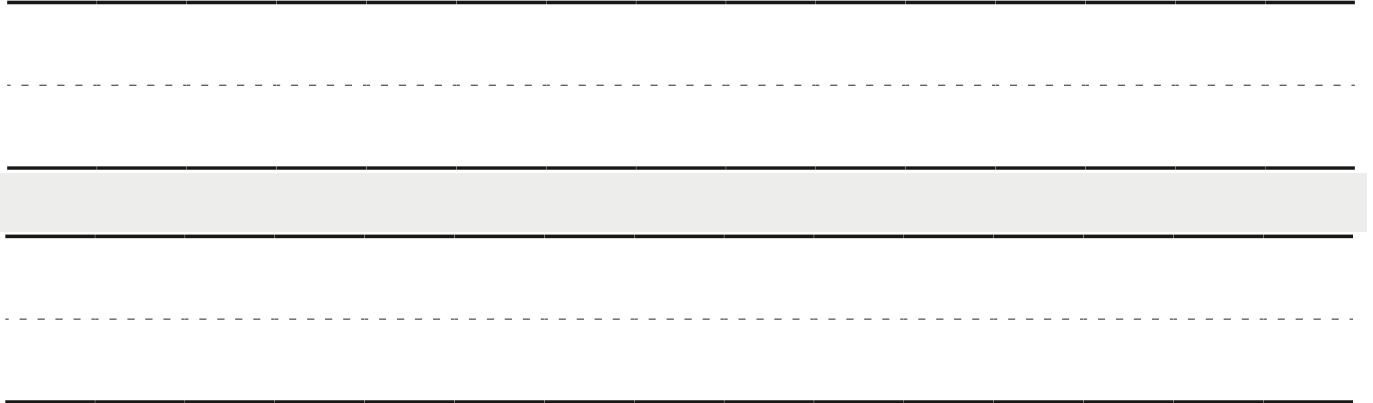
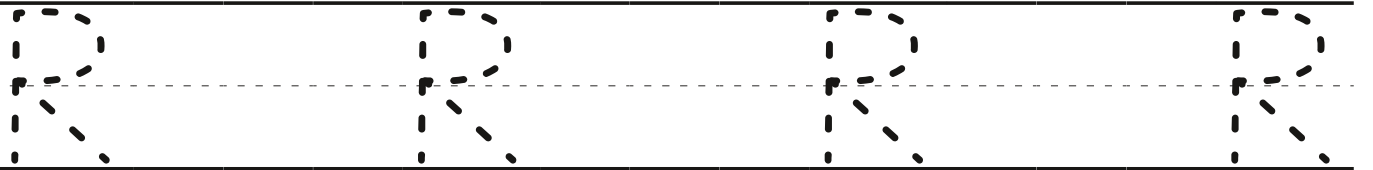
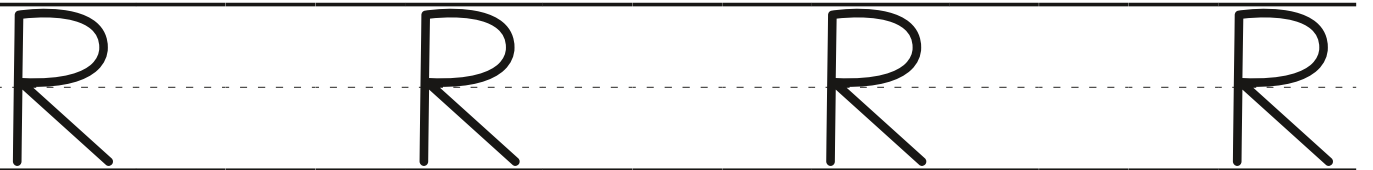

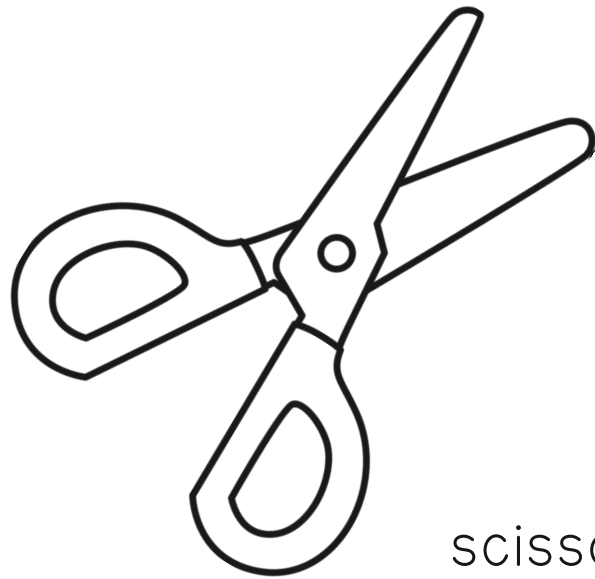
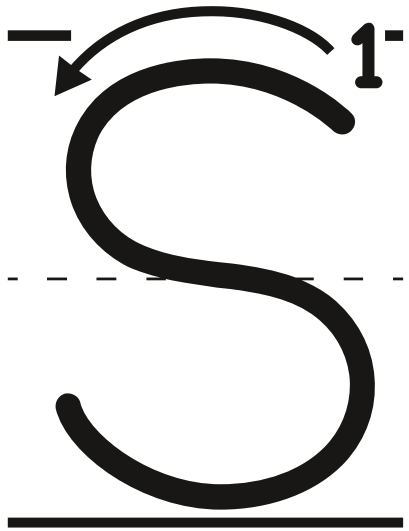

scissors

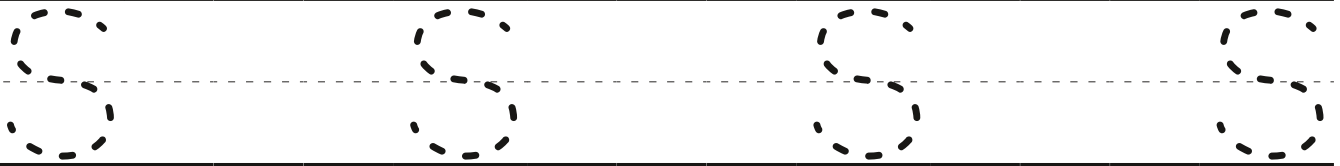
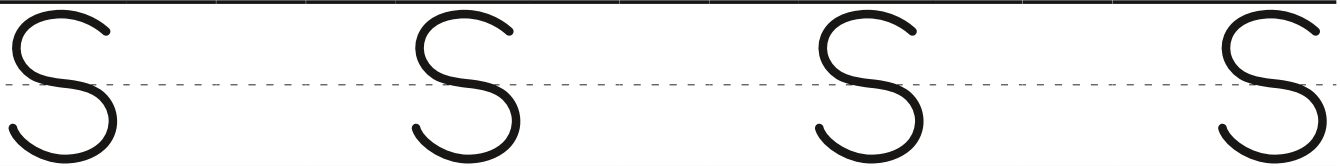

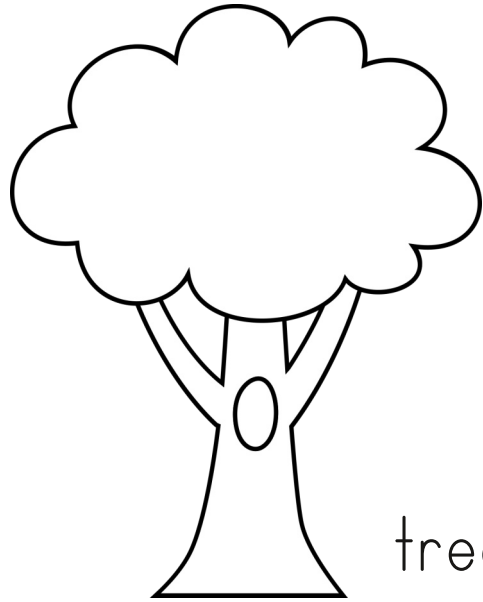
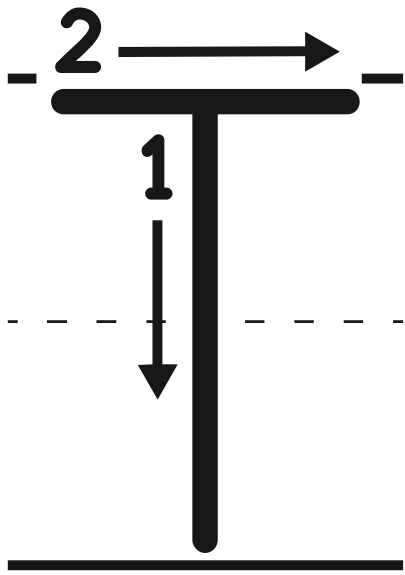

Handwriting practice lines for the letter T. Each row consists of a solid top line, a dashed middle line, and a solid bottom line. The first row contains four solid uppercase 'T's. The second row contains four dashed uppercase 'T's for tracing. The third row contains four dashed uppercase 'T's for tracing. The fourth row contains four dashed uppercase 'T's for tracing. The fifth row contains four dashed uppercase 'T's for tracing. The sixth row contains four dashed uppercase 'T's for tracing. The seventh row contains four dashed uppercase 'T's for tracing. The eighth row contains four dashed uppercase 'T's for tracing. The ninth row contains four dashed uppercase 'T's for tracing. The tenth row contains four dashed uppercase 'T's for tracing. The eleventh row contains four dashed uppercase 'T's for tracing. The twelfth row contains four dashed uppercase 'T's for tracing. The thirteenth row contains four dashed uppercase 'T's for tracing. The fourteenth row contains four dashed uppercase 'T's for tracing. The fifteenth row contains four dashed uppercase 'T's for tracing. The sixteenth row contains four dashed uppercase 'T's for tracing. The seventeenth row contains four dashed uppercase 'T's for tracing. The eighteenth row contains four dashed uppercase 'T's for tracing. The nineteenth row contains four dashed uppercase 'T's for tracing. The twentieth row contains four dashed uppercase 'T's for tracing.

CW / HW

Date: _____

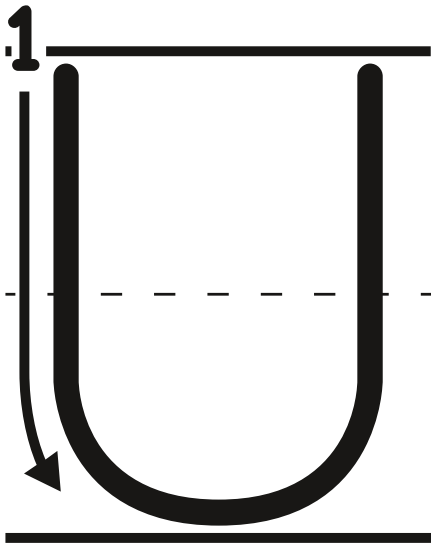

umbrella

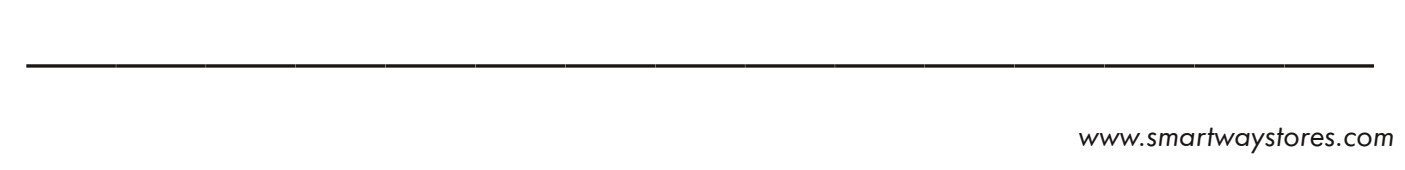
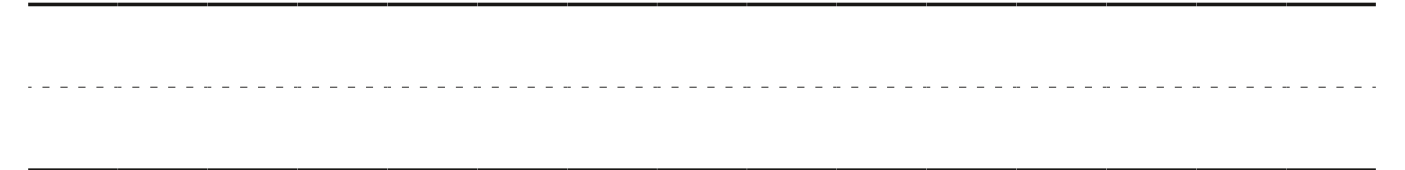
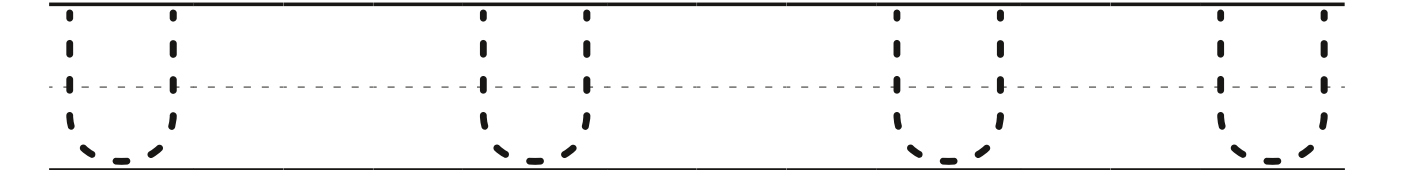
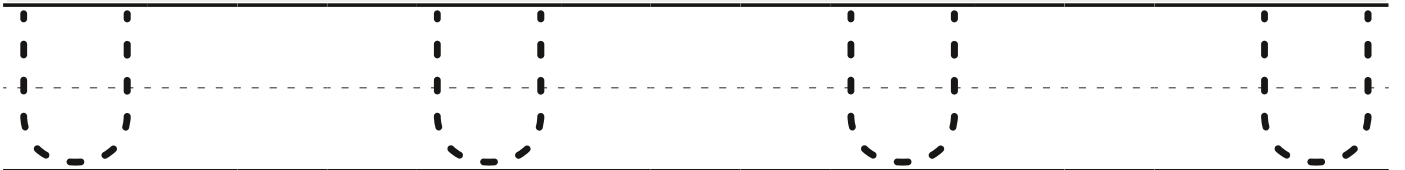
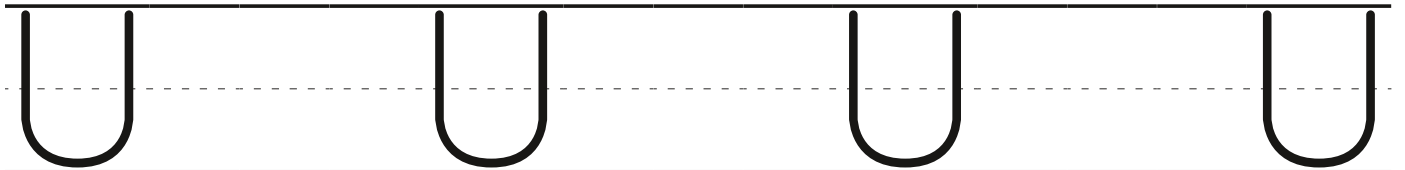

CW / HW

Date: _____

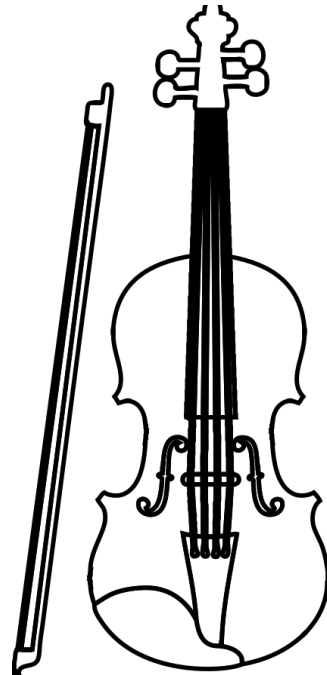
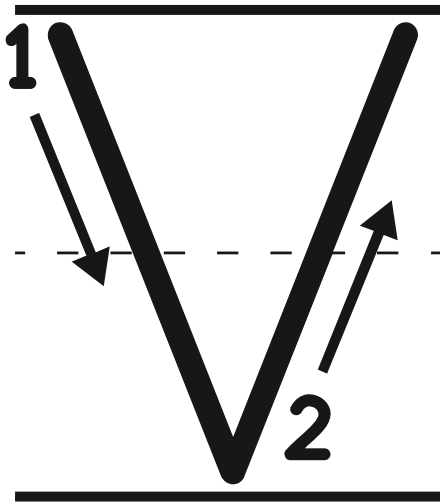

violin

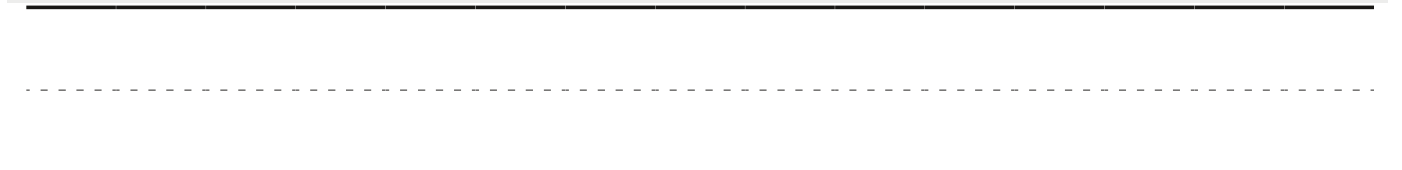
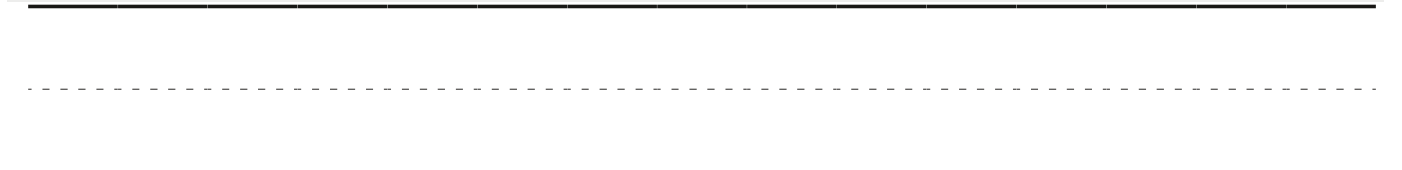
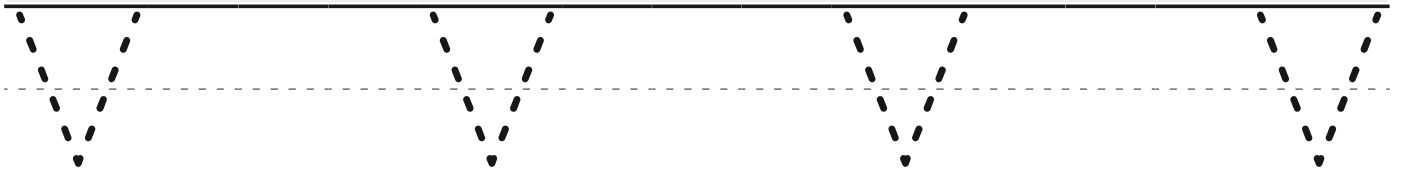
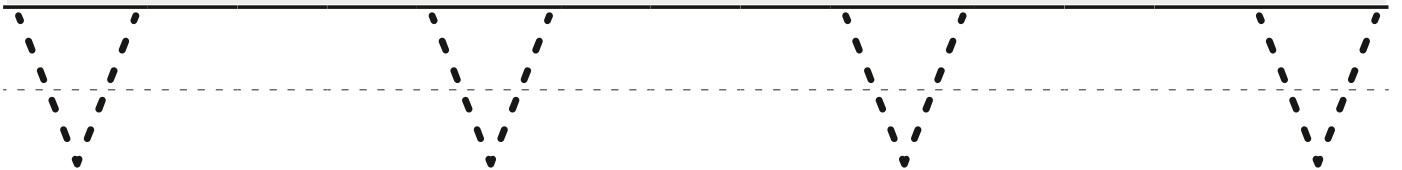
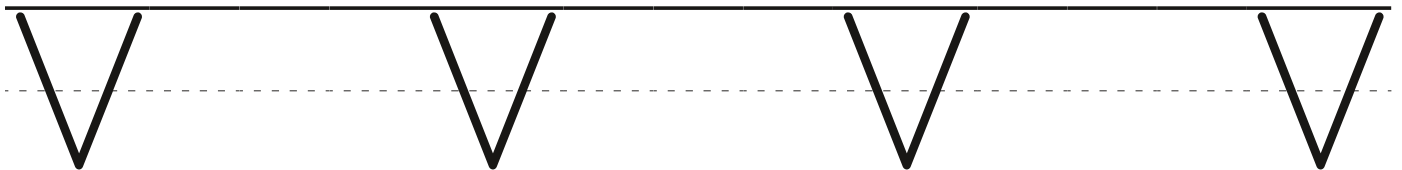

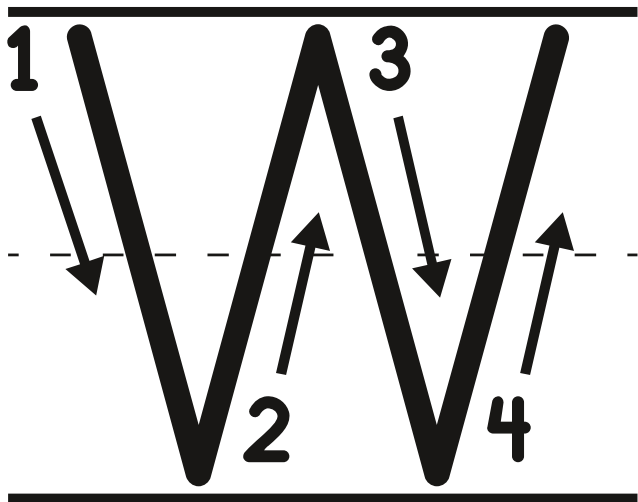

watermelon

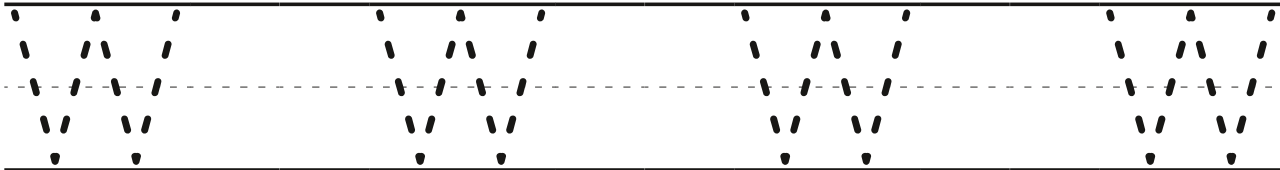
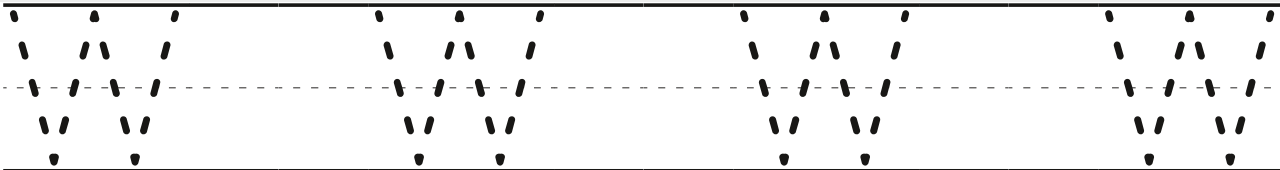
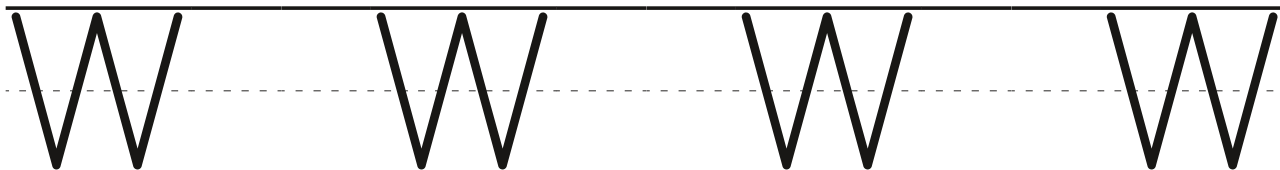

CW / HW

Date: _____

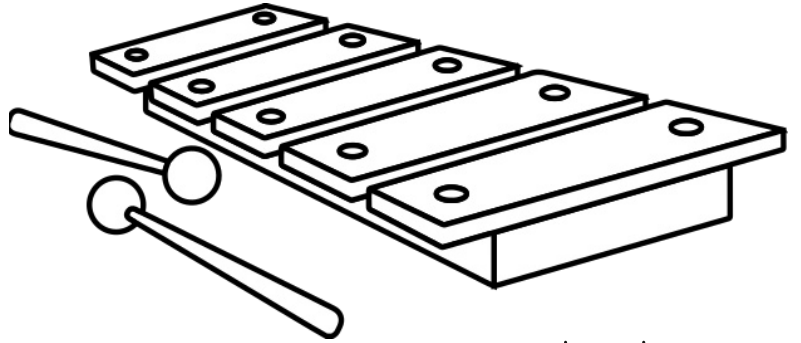
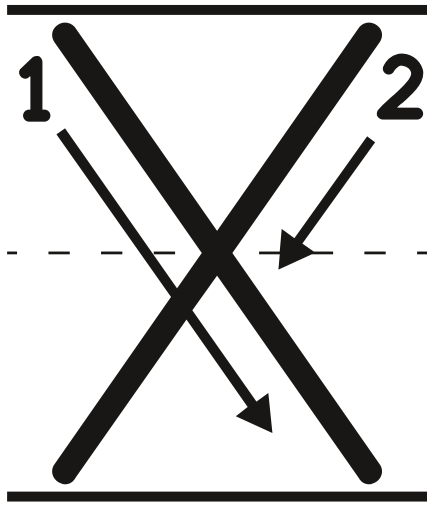

xylophone

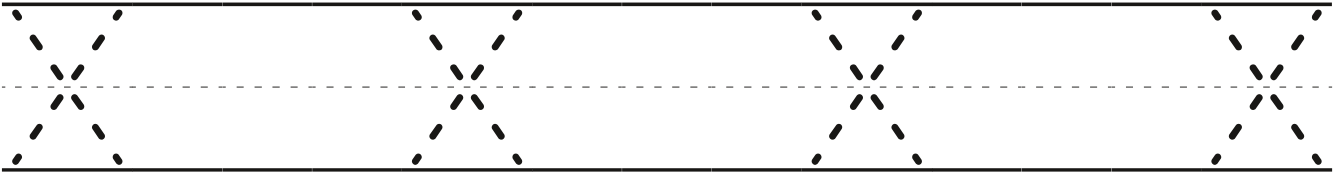
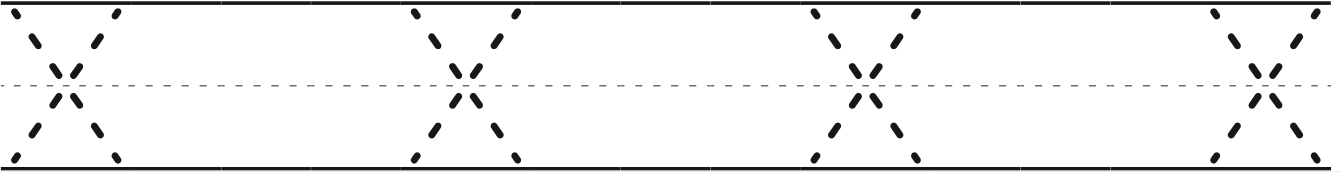
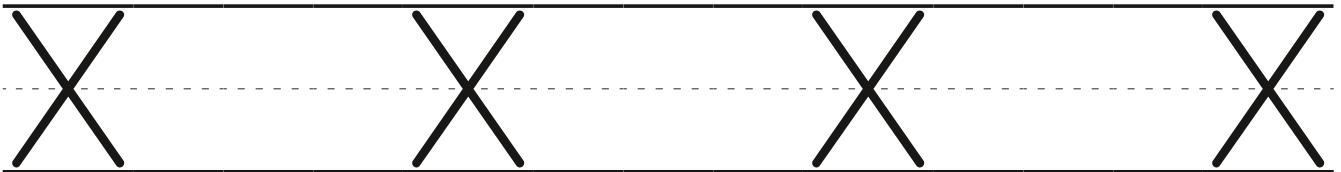

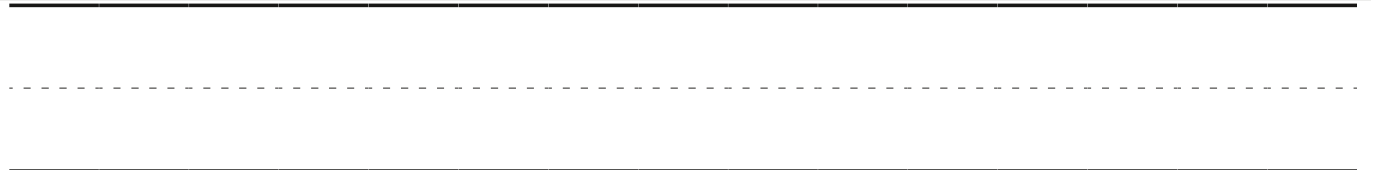
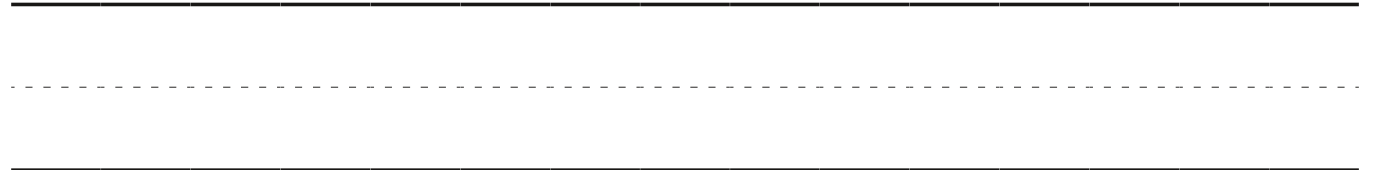
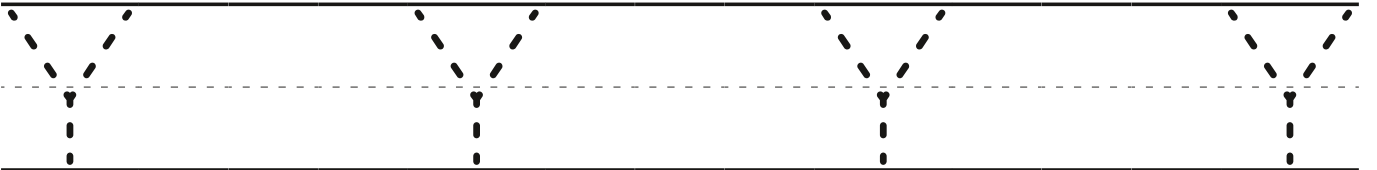
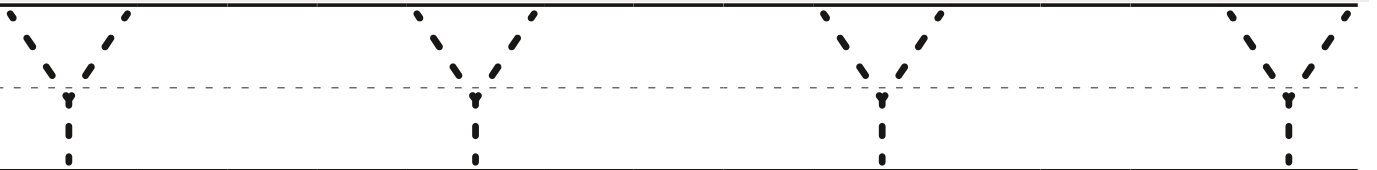
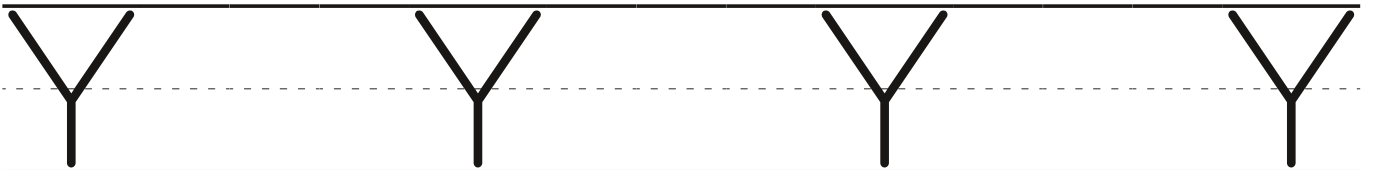
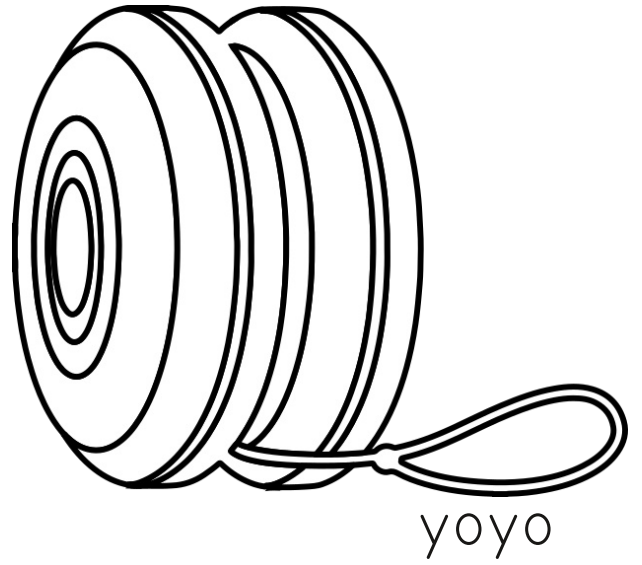
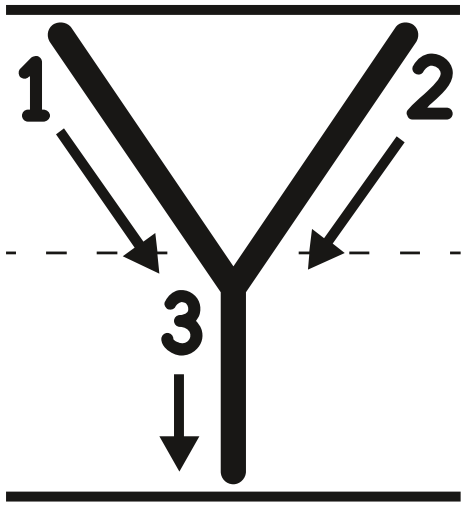

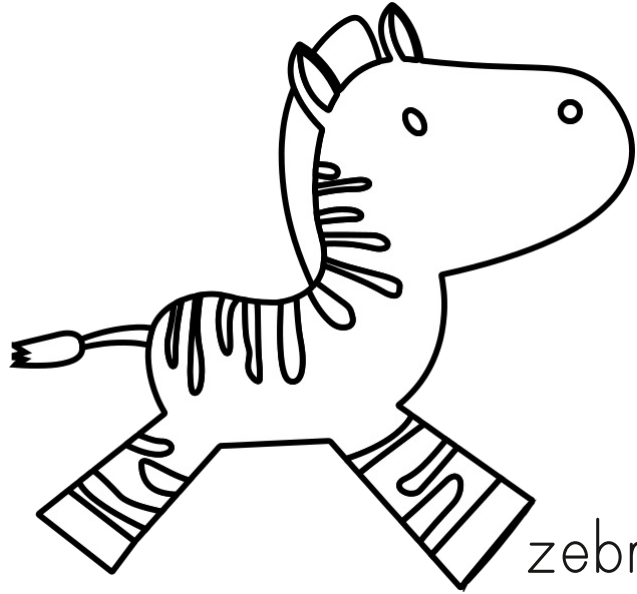
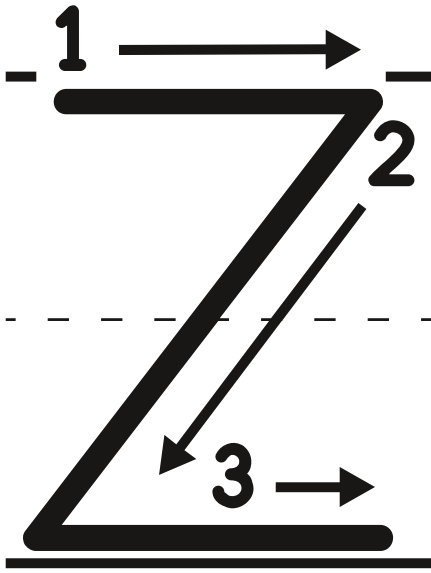

zebra

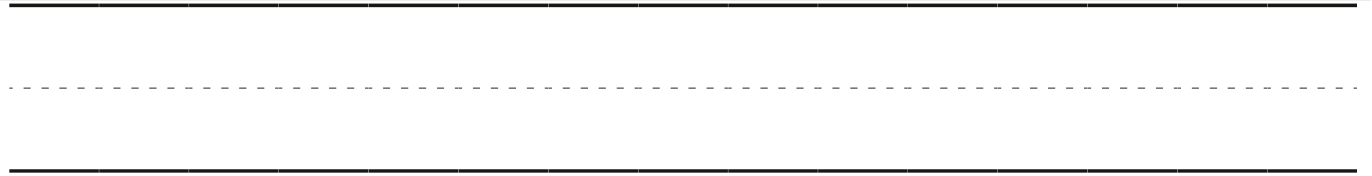
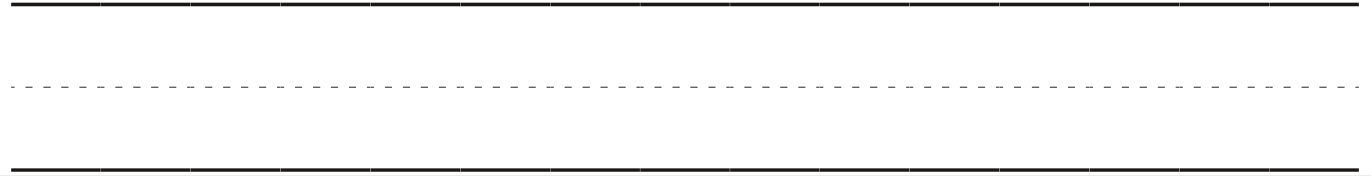
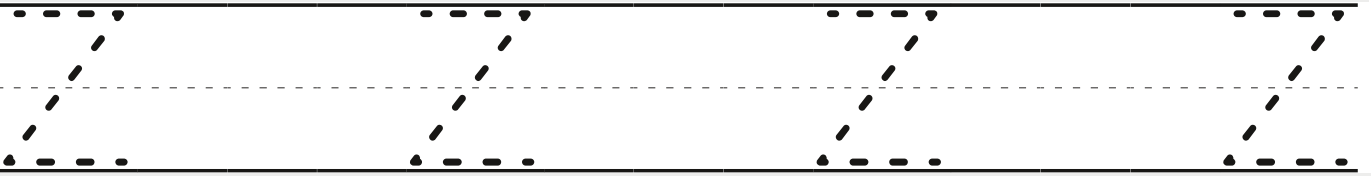
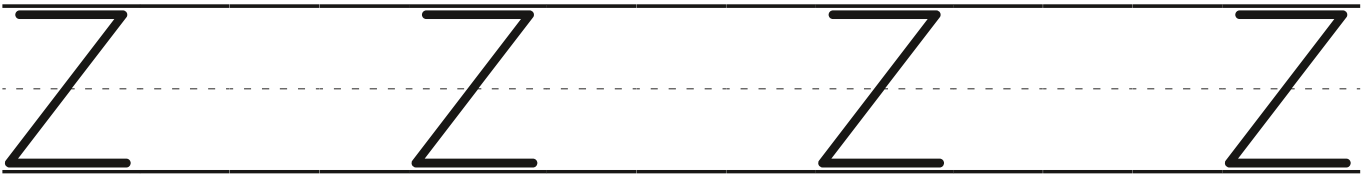

Other Relevant Resources

A-Z Letter Booklets 26 Booklets Bundle

26 Booklets x 12 pages -PDF

Letters & Pictures Posters

5 Pictures with each letter

155+ pages

LETTERS A - Z Bundle

Practice the letter name, sound, and pictures

Aa Bb Cc Dd	Gg Ee Hh Ff	Ll Kk Ii Jj
Mm Pp Nn Oo	Ss Qq Tt Rr	Ww Xx Uu Vv Yy Zz
Cc Aa Pp Dd	Pp Nn Oo Mm	Vv Yy Zz Ww Uu Xx

270 CARDS, 6 DECKS

A - Z INTERACTIVE LETTER BOOKS

Learn & Practice the letter, sound, pictures and more...

Each slide and every picture speaks

Write the beginning...
Urag and drop all the pictures in the box that begins with this letter.

26 Decks: 480+ boom cards



Browse Now